

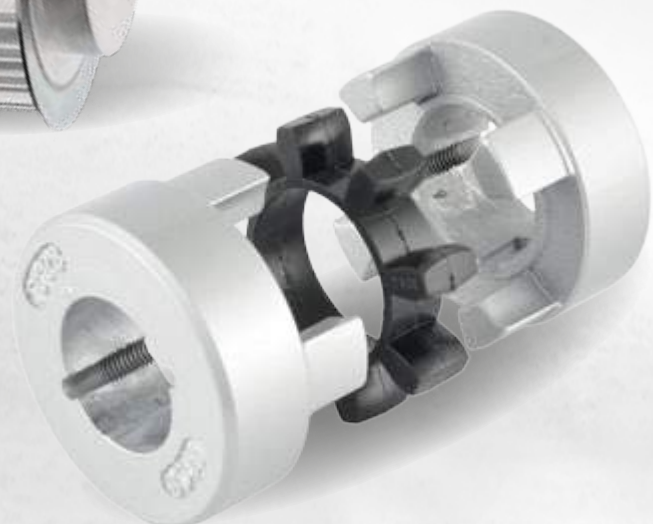

POWER TRANSMISSION
LIEFERSORTIMENT METALL

ZUM INHALTSVERZEICHNIS

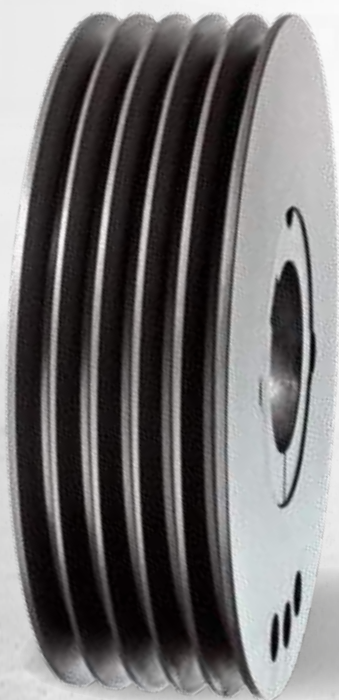

PRME-18
GÜLTIG AB
01.04.2018



„Präzision für
Ihren Antrieb.“

Norbert, 42, Vorarbeiter



OPTIBELT METALL PRODUKTE

Seite 4

optibelt TB

Taper-Buchsen mit metrischer Bohrung

Taper-Buchsen mit Zoll-Bohrung

Seite 5-20

optibelt KS

Keilrillenscheiben für Taper-Buchsen

Keilrillenscheiben für zylindrische Bohrung

Seite 21-29

optibelt RBS

Keilrippenscheiben für Taper-Buchsen

Keilrippenscheiben für zylindrische Bohrung

Keilrippenscheiben in Sondergrößen

Seite 30

optibelt FS

Flachriemenscheiben für Taper-Buchsen

Seite 32-46

optibelt ZRS

HTD-Zahnscheiben

für Taper-Buchsen

für zylindrische Bohrung

Seite 92-93

HABIX®

Steck-/Klauenkupplung mit elastischem

Element

Seite 94-95

HABIX®-PLUS

Spielfreie Steck-/Klauenkupplung mit

elastischem Element

Seite 96-97

HADEFLEX®

Steck-/Klauenkupplung mit elastischem

Element

Seite 98

HRC

Gekapselte Steck-/Klauenkupplung mit

elastischem Element

Seite 99

PEX

Gekapselte Steck-/Klauenkupplung mit

elastischen Elementen

Seite 47-48

optibelt ZRS

Delta Chain Zahnscheiben

für Taper-Buchsen

für zylindrische Bohrung

Seite 49-57

optibelt ZRS

Metrische Zahnscheiben

für zylindrische Bohrung, T-Type

für zylindrische Bohrung, AT-Type

Seite 58-69

optibelt ZRS

Standard-Zahnscheiben-zöllig

für Taper-Buchsen

für zylindrische Bohrung

Seite 70-73

optibelt ZRW

Standard-Zahnwellen

Metrische Zahnwellen

Seite 74-75

optibelt CP

Spannplatten

Spannplatten Meterware

Seite 76-77

optibelt TN

Tapernaben

Einschweissnaben Type WM, WH

Zwischenhülsen

Seite 78-90

optibelt CE

Spannelemente

KUPPLUNGEN

Seite 100

ORPEX®

Bolzenkupplung mit elastischen Elementen

Seite 101

FLEX

Hochelastische Reifenkupplung

Seite 102

Zahnkupplungen

Bogenverzahnte Zahnkupplung

Seite 103

Mini-Kupplungen

Drehstarre Kupplung

Seite 104

Starre Kupplungen

Stahl/Edelstahl

Seite 105

Schalenkupplungen DIN 115

Starre Wellenverbindung

Seite 106

Scheibenkupplungen DIN 116

Starre robuste Wellenverbindung

Ausführungen Keilrillenscheiben:

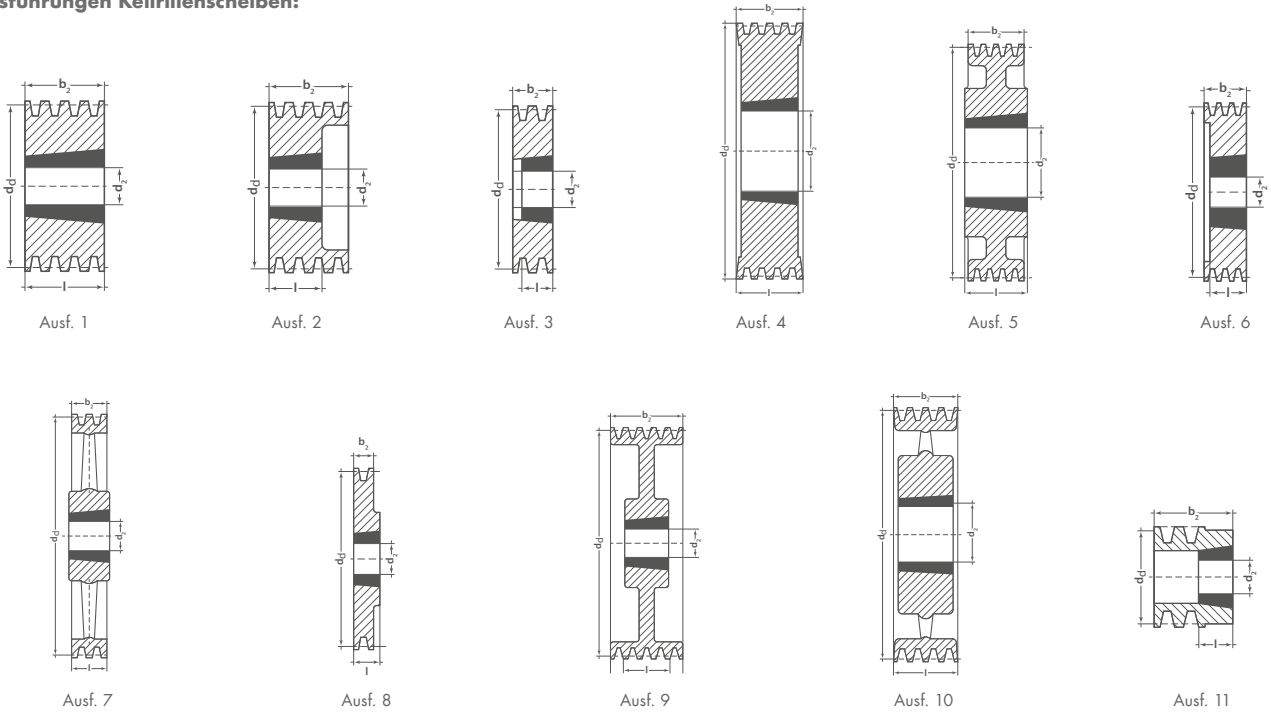

Fertigungstechnische Änderungen der Ausführungen vorbehalten.

Auswuchten:

Die Listenpreise gelten für in einer Ebene nach DIN/ISO 1940 ausgewuchtete Keilrillenscheiben wie folgt: Gütestufe G 6,3 für $\varnothing d_d \leq 400$ mm bei $n = 1500$ min⁻¹, für $\varnothing d_d > 400$ mm bei $v = 30$ m/s.

Die Auswuchtung wird ohne Nut, bzw. mit halber Passfeder auf glattem Wuchtdorn vorgenommen, dies entspricht der Wuchtart Halbkeilwuchtung. Andere Wuchtarten nach Vereinbarung.

Ein Auswuchten in zwei Ebenen Gütestufe G 6,3 wird empfohlen, wenn $v > 30$ m/s oder das Verhältnis Richtdurchmesser zu Kranzbreite $d_d : b_2 < 4$ und $v > 20$ m/s ist. Mehrpreis auf Anfrage nach Bekanntgabe der Betriebsdrehzahl.

Fertigbohrungen:

Aufschläge für Fertigbohrung H7 nach DIN 7154 und Passfedernut nach DIN 6885 Teil 1							
Stück	Fertigbohrung bis 30 mm		Fertigbohrung 31 mm bis 50 mm		Fertigbohrung 51 mm bis 75 mm		Gewindebohrung für Stellschraube
	Preis pro Stück € ohne Nut	Preis pro Stück € mit Nut	Preis pro Stück € ohne Nut	Preis pro Stück € mit Nut	Preis pro Stück € ohne Nut	Preis pro Stück € mit Nut	Preis pro Stück €
1 bis 2							
3 bis 5							
6 bis 10							
11 bis 24							
25 bis 50							
über 50							

Sonderbearbeitungen und Sonderscheiben auf Anfrage.

Richtdurchmesser d _d (mm)	Anzahl der Rillen	Ausfüh- rung	Ausfüh- rungs Nr.	Gewicht ohne Buchse (kg)	Taper- buchse	Richtdurchmesser d _d (mm)	Anzahl der Rillen	Ausfüh- rung	Ausfüh- rungs Nr.	Gewicht ohne Buchse (kg)	Taper- buchse
TB SPZ/10											
50	1	●	11	0,3	1008	112	1	●	8	1,0	1610
	2	●	11	0,4	1008		2	●	6	1,3	1610
56	1	●	11	0,4	1008		3	●	6	1,3	2012
	2	●	11	0,5	1108		4	●	6	1,5	2012
60	1	●	8	0,2	1008		5	●	6	1,8	2012
	2	●	11	0,6	1108		6*	●	6	1,9	2012
63	1	●	8	0,2	1108	118	1	●	8	0,9	1610
	2	●	6	0,3	1108		2	●	6	1,3	1610
	3	●	6	0,4	1108		3	●	6	1,6	2012
67	1	●	8	0,3	1108		4	●	6	1,8	2012
	2	●	6	0,4	1108		5	●	6	1,8	2012
	3	●	6	0,5	1108		6*	●	6	2,0	2517
71	1	●	8	0,3	1108	125	1	●	8	1,0	1610
	2	●	6	0,4	1108		2	●	6	1,4	1610
	3	●	6	0,6	1108		3	●	2	1,8	2012
75	1	●	8	0,4	1108		4	●	2	2,2	2012
	2	●	6	0,4	1210		5	●	6	2,3	2012
	3	●	6	0,5	1210		6*	●	6	2,5	2517
80	1	●	8	0,5	1210	132	1	●	8	1,1	1610
	2	●	6	0,6	1210		2	●	6	1,5	1610
	3	●	6	0,7	1210		3	●	2	2,3	2012
	4	●	6	0,8	1210		4	●	2	2,5	2012
85	1	●	8	0,6	1210		5	●	6	2,7	2517
	2	●	6	0,5	1610		6*	●	6	2,9	2517
	3	●	6	0,6	1610	140	1	●	8	1,2	1610
	4	●	6	0,9	1610		2	●	6	1,7	1610
	5	●	6	1,0	1610		3	●	2	2,6	2012
90	1	●	8	0,7	1210		4	●	2	2,9	2012
	2	●	6	0,7	1610		5	●	2	3,2	2517
	3	●	6	0,8	1610		6*	●	2	3,5	2517
	4	●	6	1,0	1610	8*	●	4	4,0	2517	
	5	●	6	1,2	1610	150	1	●	8	1,2	1610
95	1	●	8	0,7	1210		2	●	8	2,0	2012
	2	●	6	0,8	1610		3	●	2	3,1	2012
	3	●	6	0,9	1610		4	●	2	3,7	2517
	4	●	6	1,1	1610		5	●	2	4,0	2517
	5	●	6	1,3	1610		6*	●	2	4,4	2517
100	1	●	8	0,8	1210	8*	●	4	5,1	2517	
	2	●	6	0,9	1610	160	1	●	8	1,3	1610
	3	●	6	1,1	1610		2	●	8	2,5	2012
	4	●	6	1,1	1610		3	●	2	3,6	2012
	5	●	6	1,3	2012		4	●	2	4,4	2517
	6*	●	6	1,4	2012		5	●	2	4,8	2517
106	1	●	8	0,9	1610		6*	●	2	5,2	2517
	2	●	6	1,1	1610	8*	●	4	5,6	2517	
	3	●	6	1,3	1610	170	1	●	8	1,5	1610
	4	●	6	1,3	1610		2	●	8	2,5	2012
	5	●	6	1,5	2012		3	●	4	4,2	2012
	6*	●	6	1,6	2012		4	●	2	5,3	2517
					5		●	2	5,9	2517	
					6*		●	2	6,5	2517	

Richtdurchmesser d_d (mm)	Anzahl der Rillen	Ausführung	Ausführungs Nr.	Gewicht ohne Buchse (kg)	Taperbuchse	Richtdurchmesser d_d (mm)	Anzahl der Rillen	Ausführung	Ausführungs Nr.	Gewicht ohne Buchse (kg)	Taperbuchse
180	1	x	7	1,6	1610	355	1	x	7	3,5	2012
	2	○	5	2,5	2012		2	x	7	5,1	2012
	3	○	9	4,8	2012		3	x	7	7,3	2517
	4	●	2	6,1	2517		4	x	10	8,9	2517
	5	●	2	6,3	2517		5	x	10	10,0	2517
	6*	●	4	6,8	2517		6*	x	10	10,7	2517
	8*	●	4	7,1	2517		8*	x	10	16,0	3030
190	1	x	7	1,8	1610	400	1	x	7	6,0	2012
	2	○	5	2,6	2012		2	x	7	6,3	2517
	3	○	9	4,9	2012		3	x	7	8,0	2517
	4	○	9	5,3	2517		4	x	10	10,1	2517
	5	○	9	6,3	2517		5	x	10	11,7	3020
	6*	○	9	6,9	2517		6*	x	10	14,5	3030
200	1	x	7	2,3	2012	450	8*	x	10	18,2	3030
	2	x	7	2,8	2012		1*	x	7	6,1	2517
	3	x	10	3,5	2012		2*	x	7	8,2	2517
	4	○	9	4,7	2517		3*	x	7	9,8	2517
	5	○	9	5,5	2517		4*	x	10	11,8	3020
	6*	○	9	6,1	2517		5*	x	10	13,9	3020
	8*	●	4	9,3	3020		6*	x	10	16,9	3030
224	1	x	7	2,5	2012	500	8*	x	10	24,0	3535
	2	x	7	3,2	2012		2*	x	7	9,1	2517
	3	x	10	3,9	2012		3*	x	7	11,4	2517
	4	x	10	5,2	2517		4*	x	10	14,3	3020
	5	x	10	6,0	2517		5*	x	7	17,6	3030
	6*	x	10	6,6	2517		6*	x	10	19,9	3030
	8*	●	4	11,8	3020		630	3*	x	7	15,9
250	1	x	7	2,8	2012	4*		x	7	20,0	3030
	2	x	7	3,5	2012	5*		x	7	22,7	3030
	3	x	10	4,3	2012	6*		x	7	33,6	3535
	4	x	10	5,7	2517	280	1	x	7	2,9	2012
	5	x	10	6,4	2517		2	x	7	4,0	2012
	6*	x	10	7,0	2517		3	x	7	5,3	2517
	8*	x	10	10,5	3020		4	x	10	6,4	2517
315	1	x	7	3,1	2012		5	x	10	7,1	2517
	2	x	7	4,2	2012		6*	x	10	7,8	2517
	3	x	7	6,1	2517	8*	x	10	10,8	3020	
	4	x	10	7,6	2517	250	1	x	7	2,8	2012
	5	x	10	8,6	2517		2	x	7	3,5	2012
	6*	x	10	9,3	2517		3	x	10	4,3	2012
180	1	x	7	1,6	1610		4	x	10	5,7	2517
	2	○	5	2,5	2012		5	x	10	6,4	2517
	3	○	9	4,8	2012		6*	x	10	7,0	2517
	4	●	2	6,1	2517	8*	x	10	10,5	3020	
	5	●	2	6,3	2517	190	1	x	7	1,8	1610
	6*	●	4	6,8	2517		2	○	5	2,6	2012
8*	●	4	7,1	2517	3		○	9	4,9	2012	
190	1	x	7	1,8	1610		4	○	9	5,3	2517
	2	○	5	2,6	2012		5	○	9	6,3	2517
	3	○	9	4,9	2012		6*	○	9	6,9	2517
	4	○	9	5,3	2517	200	1	x	7	2,3	2012
	5	○	9	6,3	2517		2	x	7	2,8	2012
	6*	○	9	6,9	2517		3	x	10	3,5	2012
200	1	x	7	2,3	2012		4	○	9	4,7	2517
	2	x	7	2,8	2012		5	○	9	5,5	2517
	3	x	10	3,5	2012		6*	○	9	6,1	2517
	4	○	9	4,7	2517	8*	●	4	9,3	3020	
	5	○	9	5,5	2517	224	1	x	7	2,5	2012
	6*	○	9	6,1	2517		2	x	7	3,2	2012
8*	●	4	9,3	3020	3		x	10	3,9	2012	
224	1	x	7	2,5	2012		4	x	10	5,2	2517
	2	x	7	3,2	2012		5	x	10	6,0	2517
	3	x	10	3,9	2012		6*	x	10	6,6	2517
	4	x	10	5,2	2517	8*	●	4	11,8	3020	
	5	x	10	6,0	2517	250	1	x	7	2,8	2012
	6*	x	10	6,6	2517		2	x	7	3,5	2012
8*	●	4	11,8	3020	3		x	10	4,3	2012	
250	1	x	7	2,8	2012		4	x	10	5,7	2517
	2	x	7	3,5	2012		5	x	10	6,4	2517
	3	x	10	4,3	2012		6*	x	10	7,0	2517
	4	x	10	5,7	2517	8*	x	10	10,5	3020	
	5	x	10	6,4	2517	280	1	x	7	2,9	2012
	6*	x	10	7,0	2517		2	x	7	4,0	2012
8*	x	10	10,5	3020	3		x	7	5,3	2517	
280	1	x	7	2,9	2012		4	x	10	6,4	2517
	2	x	7	4,0	2012		5	x	10	7,1	2517
	3	x	7	5,3	2517		6*	x	10	7,8	2517
	4	x	10	6,4	2517	8*	x	10	10,8	3020	
	5	x	10	7,1	2517	315	1	x	7	3,1	2012
	6*	x	10	7,8	2517		2	x	7	4,2	2012
8*	x	10	10,8	3020	3		x	7	6,1	2517	
315	1	x	7	3,1	2012		4	x	10	7,6	2517
	2	x	7	4,2	2012		5	x	10	8,6	2517
	3	x	7	6,1	2517		6*	x	10	9,3	2517
	4	x	10	7,6	2517	180	1	x	7	1,6	1610
	5	x	10	8,6	2517		2	○	5	2,5	2012
	6*	x	10	9,3	2517		3	○	9	4,8	2012
180	1	x	7	1,6	1610		4	●	2	6,1	2517
	2	○	5	2,5	2012		5	●	2	6,3	2517
	3	○	9	4,8	2012		6*	●	4	6,8	2517
	4	●	2	6,1	2517	8*	●	4	7,1	2517	
	5	●	2	6,3	2517	190	1	x	7	1,8	1610
	6*	●	4	6,8	2517		2	○	5	2,6	2012
8*	●	4	7,1	2517	3		○	9	4,9	2012	
190	1	x	7	1,8	1610		4	○	9	5,3	2517
	2	○	5	2,6	2012		5	○	9	6,3	2517
	3	○	9	4,9	2012		6*	○	9	6,9	2517
	4	○	9	5,3	2517	200	1	x	7	2,3	2012
	5	○	9	6,3	2517		2	x	7	2,8	2012
	6*	○	9	6,9	2517		3	x	10	3,5	2012
200	1	x	7	2,3	2012		4	○	9	4,7	2517
	2	x	7	2,8	2012		5	○	9	5,5	2517
	3	x	10	3,5	2012		6*	○	9	6,1	2517
	4	○	9	4,7	2517	8*	●	4	9,3	3020	
	5	○	9	5,5	2517	224	1	x	7	2,5	2012
	6*	○	9	6,1	2517		2	x	7	3,2	2012
8*	●	4	9,3	3020	3		x	10	3,9	2012	
224	1	x	7	2,5	2012		4	x	10	5,2	2517
	2	x	7	3,2	2012		5	x	10	6,0	2517
	3	x	10	3,9	2012		6*	x	10	6,6	2517
	4	x	10	5,2	2517	8*	●	4	11,8	3020	
	5	x	10	6,0	2517	250	1	x	7	2,8	2012
	6*	x	10	6,6	2517		2	x	7	3,5	2012
8*	●	4	11,8	3020	3		x	10	4,3	2012	
250	1	x	7	2,8	2012		4	x	10	5,7	2517
	2	x	7	3,5	2012		5	x	10	6,4	2517
	3	x	10	4,3	2012		6*	x	10	7,0	2517
	4	x	10	5,7	2517	8*	x	10	10,5	3020	
	5	x	10	6,4	2517	280	1	x	7	2,9	2012
	6*	x	10	7,0	2517		2	x	7	4,0	2012
8*	x	10	10,5	3020	3		x	7	5,3	2517	
280	1	x	7	2,9	2012		4	x	10	6,4	2517
	2	x	7	4,0	2012		5	x	10	7,1	2517
	3	x	7	5,3	2517		6*	x	10	7,8	2517
	4	x	10	6,4	2517	8*	x	10	10,8	3020	
	5	x	10	7,1	2517	315	1	x	7	3,1	2012
	6*	x	10	7,8	2517		2	x	7	4,2	2012
8*	x	10	10,8	3020	3		x	7	6,1	2517	
315	1	x	7	3,1	2012		4	x	10	7,6	2517
	2	x	7	4,2	2012		5	x	10	8,6	2517
	3	x	7	6,1	2517		6*	x	10	9,3	2517
	4	x	10	7,6	2517	180	1	x	7	1,6	1610
	5	x	10	8,6	2517		2	○	5	2,5	2012
	6*	x	10	9,3	2517		3	○	9	4,8	2012
180	1	x	7	1,6	1610		4	●	2	6,1	2517
	2	○	5	2,5	2012		5	●	2	6,3	2517
	3	○	9	4,8	2012		6*	●	4	6,8	2517
	4	●	2	6,1	2517	8*	●	4	7,1	2517	
	5	●	2	6,3	2517	190	1	x	7	1,8	1610
	6*	●	4	6,8	2517		2	○	5	2,6	2012
8*	●	4	7,1	2517	3		○	9	4,9	2012	
190	1	x	7	1,8	1610		4	○	9	5,3	2517
	2	○	5	2,6	2012		5	○	9	6,3	2517
	3	○	9	4,9	2012		6*	○	9	6,9	2517
	4	○	9	5,3	2517	200	1	x	7	2,3	2012
	5	○	9	6,3	2517		2	x	7	2,8	2012
	6*	○	9	6,9	2517		3	x	10	3,5	2012
200	1	x	7	2,3	2012		4	○	9	4,7	2517
	2	x	7	2,8	2012		5	○	9	5,5	2517
	3	x	10	3,5	2012		6*	○	9	6,1	2517
	4	○	9	4,7	2517	8*	●	4	9,3	3020	
	5	○	9	5,5	2517	224	1	x	7	2,5	2012
	6*	○	9	6,1	2517		2	x	7	3,2	2012
8*	●	4	9,3	3020	3		x	10	3,9	2012	
224	1	x	7	2,5	2012		4	x	10	5,2	2517
	2										

Richtdurchmesser d _d (mm)	Anzahl der Rillen	Ausfüh- rung	Ausfüh- rungs Nr.	Gewicht ohne Buchse (kg)	Taper- buchse	Richtdurchmesser d _d (mm)	Anzahl der Rillen	Ausfüh- rung	Ausfüh- rungs Nr.	Gewicht ohne Buchse (kg)	Taper- buchse
TB SPA/13											
63	1	●	8	0,6	1008	132	1	●	8	1,6	1610
	2	●	6	0,8	1008		2	●	6	1,8	2012
67	1	●	8	0,3	1108		3	●	2	2,3	2012
	2	●	6	0,5	1108		4	●	2	2,6	2517
71	1	●	8	0,3	1108		5	●	4	2,9	2517
	2	●	6	0,5	1108	140	1	●	8	1,8	1610
	3	●	6	0,7	1108		2	●	6	2,0	2012
75	1	●	8	0,4	1108		3	●	6	2,8	2517
	2	●	6	0,6	1108		4	●	2	3,1	2517
	3	●	6	0,8	1108		5	●	4	3,4	2517
80	1	●	8	0,5	1210	150	1	●	8	1,4	1610
	2	●	6	0,6	1210		2	●	6	2,4	2012
	3	●	6	0,9	1210		3	●	6	3,5	2517
85	1	●	8	0,6	1210		4	●	2	3,8	2517
	2	●	6	0,7	1210		5	●	4	4,2	2517
	3	●	6	1,0	1210	160	1	●	8	1,9	1610
90	1	●	8	0,7	1210		2	●	6	2,9	2012
	2	●	6	0,7	1610		3	●	6	3,9	2517
	3	●	6	1,0	1610		4	●	2	4,4	2517
	4	●	6	1,2	1615		5	●	4	5,1	2517
95	1	●	8	0,8	1210	170	1	●	8	2,0	1610
	2	●	6	0,9	1610		2	●	6	3,1	2012
	3	●	6	1,1	1610		3	●	6	4,6	2517
	4	●	6	1,4	1615		4	●	2	5,5	2517
100	1	●	8	0,8	1610		5	●	4	5,9	2517
	2	●	6	0,9	1610	180	1	x	7	2,1	1610
	3	●	2	1,2	1610		2	○	9	3,4	2012
	4	●	2	1,7	1615		3	●	6	5,1	2517
	5	●	2	1,9	1615		4	●	2	5,9	2517
5	●	2	1,9	1615	5		●	4	6,2	3020	
106	1	●	8	0,9	1610	190	1	x	7	2,3	1610
	2	●	6	1,1	1610		2	○	9	3,8	2012
	3	●	2	1,4	1610		3	●	6	5,4	2517
	4	●	6	2,0	2012		4	●	2	6,8	2517
	5	●	6	2,0	2012		5	●	2	7,4	3020
112	1	●	8	1,0	1610	200	1	x	7	2,6	2012
	2	●	6	1,2	1610		2	○	5	4,1	2517
	3	●	6	1,3	2012		3	○	9	4,9	2517
	4	●	6	1,9	2012		4	●	2	7,4	3020
	5	●	6	2,1	2012		5	●	4	8,4	3020
118	1	●	8	1,2	1610	212	1	x	7	2,7	2012
	2	●	6	1,4	1610		2	x	7	4,3	2517
	3	●	2	1,8	2012		3	x	10	5,2	2517
	4	●	2	2,0	2012		4	●	2	7,3	3020
	5	●	2	2,4	2012		5	●	2	8,2	3020
125	1	●	8	1,4	1610	224	1	x	7	2,7	2012
	2	●	6	1,7	1610		2	x	7	4,4	2517
	3	●	2	2,0	2012		3	x	10	5,5	2517
	4	●	2	2,5	2012		4	●	2	7,4	3020
	5	●	4	2,7	2012		5	●	2	8,3	3020



Richtdurchmesser d_d (mm)	Anzahl der Rillen	Ausführung	Ausführungs Nr.	Gewicht ohne Buchse (kg)	Taperbuchse	Richtdurchmesser d_d (mm)	Anzahl der Rillen	Ausführung	Ausführungs Nr.	Gewicht ohne Buchse (\approx kg)	Taperbuchse
236	1	x	7	2,8	2012	630	1*	x	7	10,1	2517
	2	x	7	4,6	2517		2*	x	7	16,0	3020
	3	x	10	5,7	2517		3	x	7	22,0	3020
	4	○	9	7,8	3020		4	x	7	30,8	3535
	5	○	9	8,7	3020		5	x	7	33,7	3535
250	1	x	7	2,9	2012						
	2	x	7	4,8	2517						
	3	x	10	5,9	2517						
	4	x	10	8,0	3020						
	5	○	9	9,0	3020						
280	1	x	7	3,3	2012						
	2	x	7	5,4	2517						
	3	x	10	6,7	2517						
	4	x	10	8,8	3020						
	5	x	7	15,5	3535						
300	1	x	7	4,5	2012						
	2	x	7	6,8	2517						
	3	x	10	8,2	3020						
	4	x	10	11,3	3020						
	5	○	5	19,0	3535						
315	1	x	7	3,6	2012						
	2	x	7	6,0	2517						
	3	x	7	8,3	3020						
	4	x	10	9,7	3020						
	5	x	7	17,0	3535						
355	1	x	7	4,2	2012						
	2	x	7	6,7	2517						
	3	x	7	9,2	3020						
	4	x	10	11,0	3020						
	5	x	7	18,6	3535						
400	1	x	7	4,9	2012						
	2	x	7	8,1	2517						
	3	x	7	11,0	3020						
	4	x	10	12,8	3020						
	5	x	7	21,0	3535						
450	1*	x	7	7,0	2012						
	2	x	7	10,3	2517						
	3	x	7	14,1	3020						
	4	x	10	15,5	3020						
	5	x	7	24,3	3535						
500	1*	x	7	8,0	2517						
	2	x	7	11,6	2517						
	3	x	7	16,0	3020						
	4	x	10	18,2	3020						
	5	x	7	27,3	3535						
560	1*	x	7	11,6	2517						
	2	x	7	15,5	3020						
	3	x	7	17,8	3020						
	4	x	7	26,7	3535						
	5	x	7	30,4	3535						

Anzahl der Rillen	1	2	3	4	5
Kranzbreite b_2 (mm)	20	35	50	65	80

Taper-Buchse	1008	1108	1210	1610	1615	2012	2517	3020	3535
Bohrung d_2 (mm) von... bis...	10-25	10-28	11-32	14-42	14-42	14-50	16-65	25-75	35-90

● Vollscheibe ○ Bodenscheibe (mit oder ohne Spiegel) x Armscheibe
Material: EN-GJL 200
* Keine Lagerware
Bohrungsdurchmesser d_2 siehe Seite 4

Fertigungstechnische Änderungen vorbehalten.

Richtdurchmesser d _d (mm)	Anzahl der Rillen	Ausfüh- rung	Ausfüh- rungs Nr.	Gewicht ohne Buchse (kg)	Taper- buchse	Richtdurchmesser d _d (mm)	Anzahl der Rillen	Ausfüh- rung	Ausfüh- rungs Nr.	Gewicht ohne Buchse (kg)	Taper- buchse
TB SPB/17											
100	1	●	8	0,9	1610	180	1	○	9	4,1	1610
	2	●	6	1,2	1610		2	●	8	4,5	2517
	3	●	6	1,7	1610		3	●	2	5,5	2517
106	1	●	8	1,0	1610		4	●	4	6,9	2517
	2	●	6	1,35	1610		5	●	4	7,1	3020
	3	●	6	1,85	1610		6	●	4	7,7	3020
112	1	●	8	1,1	1610		8	●	4	9,5	3030
	2	●	6	1,5	1610		190	1	○	5	4,6
	3	●	6	2,0	1610	2		●	8	5,0	2517
118	1	●	8	1,3	1610	3		●	2	6,3	2517
	2	●	2	1,7	1610	4		●	4	7,6	2517
	3	●	2	2,3	1610	5		●	4	8,1	3020
125	1	●	8	1,5	1610	6		●	4	9,2	3020
	2	●	2	1,9	2012	8		●	4	11,2	3030
	3	●	2	2,4	2012	200		1	x	7	5,0
	4	●	4	3,0	2012		2	●	8	5,4	2517
	5	●	6	3,5	2012		3	●	2	6,5	2517
132	1	●	8	1,8	1610		4	●	4	8,8	3020
	2	●	2	2,2	2012		5	●	4	9,1	3020
	3	●	2	2,8	2012		6	●	4	10,3	3020
	4	●	4	3,4	2012		8	●	4	13,5	3535
	5	●	6	3,7	2517		212	1	x	7	4,2
140	1	●	8	2,3	1610	2		○	5	4,9	2517
	2	●	2	2,7	2012	3		○	9	6,0	2517
	3	●	2	3,3	2012	4		●	4	9,8	3020
	4	●	4	3,7	2517	5		●	4	11,0	3020
	5	●	4	4,5	2517	6		●	4	14,3	3535
	6	●	4	4,6	2517	8		●	4	16,6	3535
150	1	●	8	2,7	1610	224		1	x	7	4,7
	2	●	2	3,1	2012		2	x	7	5,3	2517
	3	●	2	3,9	2517		3	x	10	6,3	2517
	4	●	4	4,4	2517		4	●	4	11,3	3020
	5	●	4	5,2	2517		5	●	4	12,7	3020
	6	●	4	5,6	2517		6	●	4	17,0	3535
160	1	●	8	2,8	1610		8	●	4	19,3	3535
	2	●	2	3,9	2012		10	●	4	21,8	3535
	3	●	2	4,8	2517	236	1	x	7	5,0	2012
	4	●	4	5,7	2517		2	x	7	5,5	2517
	5	●	4	6,6	2517		3	x	10	7,0	2517
	6	●	4	6,5	3020		4	●	4	14,5	3020
	8	●	4	8,0	3020		5	●	4	16,9	3535
170	1	●	8	2,9	1610		6	●	4	20,0	3535
	2	●	2	3,3	2012		8	●	4	22,3	3535
	3	●	2	4,9	2517		10	●	4	25,3	3535
	4	●	4	5,7	2517						
	5	●	4	6,1	3020						
	6	●	4	6,5	3020						
	8	●	4	8,0	3030						



Richtdurchmesser d _d (mm)	Anzahl der Rillen	Ausführung	Ausführungs Nr.	Gewicht ohne Buchse (kg)	Taperbuchse	Richtdurchmesser d _d (mm)	Anzahl der Rillen	Ausführung	Ausführungs Nr.	Gewicht ohne Buchse (kg)	Taperbuchse	
250	1	x	7	5,4	2012	375	2	x	7	9,5	3020	
	2	x	7	5,5	2517		3	x	10	11,5	3020	
	3	x	10	7,7	3020		4	x	7	16,5	3535	
	4	x	10	19,6	3020		6	x	10	25,0	3535	
	5	●	4	21,7	3535		8	x	10	28,0	3535	
	6	●	4	23,3	3535		400	2	x	7	10,0	3020
	8	●	4	27,5	3535			3	x	7	18,3	3535
	10	●	4	29,3	3535			4	x	7	20,5	3535
265	2	x	7	6,2	2517	5		x	10	23,4	3535	
	3	○	9	8,0	3020	6		x	10	25,1	3535	
	4	○	9	9,5	3020	8		x	10	36,5	4040	
	6	●	4	16,7	3535	10		x	10	41,0	4040	
	8	●	4	24,0	3535	425		2	x	7	11,5	3020
280	1	x	7	6,1	2012		3	x	7	18,0	3535	
	2	x	7	6,8	2517		4	x	7	19,5	3535	
	3	x	10	8,6	3020		6	x	10	25,1	3535	
	4	x	10	10,1	3020		8	x	10	52,5	4040	
	5	○	9	17,8	3535		450	2	x	7	12,1	3020
	6	○	9	19,6	3535			3	x	7	21,9	3535
	8	○	9	26,7	3535			4	x	7	24,5	3535
	300	10	○	9	30,5	3535		5	x	10	27,3	3535
2		x	7	7,3	2517	6		x	10	35,5	4040	
3		x	10	9,2	3020	8		x	10	40,9	4040	
4		x	7	14,3	3535	10		x	10	53,5	4545	
5		x	10	18,2	3535	500		2	x	7	13,2	3020
6		x	10	21,9	3535		3	x	7	23,1	3535	
8	○	9	26,2	3535	4		x	7	26,6	3535		
315	1*	x	7	7,2	2012		5	x	10	29,9	3535	
	2	x	7	7,8	2517		6	x	10	38,9	4040	
	3	x	10	9,6	3020		8	x	10	45,5	4040	
	4	x	7	17,1	3535		10	x	10	61,0	4545	
	5	x	10	18,8	3535		560	2*	x	7	16,5	3030
	6	x	10	23,0	3535	3		x	7	25,9	3535	
	8	x	10	26,0	3535	4		x	7	29,0	3535	
	10	○	9	31,5	3535	5		x	7	35,3	4040	
335	2	x	7	7,8	2517	6		x	10	43,1	4040	
	3	x	10	10,5	3020	8		x	10	49,0	4545	
	4	x	7	18,3	3535	10		x	10	55,7	4545	
	5	x	10	19,5	3535	630		2*	x	7	18,5	3030
	6	x	10	22,0	3535		3	x	7	28,9	3535	
	8	x	10	28,2	3535		4	x	7	33,3	3535	
	10	x	10	36,0	4040		5	x	7	43,1	4040	
	355	2	x	7	8,7		3020	6	x	10	49,2	4040
3		x	10	12,1	3020		8	x	10	62,0	4545	
4		x	7	18,6	3535		10	x	10	72,0	4545	
5		x	10	20,8	3535		710	3	x	7	33,2	3535
6		x	10	22,8	3535	4		x	7	39,1	3535	
8		x	10	32,0	3535	5		x	7	50,2	4040	
10		x	10	38,0	4040	6		x	10	62,3	4040	
						8		x	10	71,0	4545	
					10	x		10	80,0	4545		

Richtdurchmesser d _d (mm)	Anzahl der Rillen	Ausführung	Ausführungs Nr.	Gewicht ohne Buchse (kg)	Taperbuchse	Richtdurchmesser d _d (mm)	Anzahl der Rillen	Ausführung	Ausführungs Nr.	Gewicht ohne Buchse (kg)	Taperbuchse	
TB SPC/22						TB SPC/22						
200	3	●	4	9,0	2517	335	3	x	7	22,5	3535	
	4	●	4	10,5	3020		4	x	10	26,5	3535	
	5	●	4	14,0	3535		5	x	10	30,0	3535	
	6	●	4	17,0	3535		6	x	10	35,0	3535	
212	3	●	4	10,0	3020		8	○	9	58,0	4040	
	4	●	4	12,5	3020		10	●	4	77,0	4545	
	5	●	4	15,0	3535		12	●	4	82,0	5050	
	6	●	4	18,0	3535		355	3	x	7	28,0	3535
224	3	●	4	11,0	3020			4	x	10	31,0	3535
	4	●	4	14,0	3535			5	x	10	34,0	3535
	5	●	4	16,2	3535			6	x	10	37,5	3535
	6	●	4	19,0	3535			8	x	10	49,5	4040
	8	●	4	24,9	3535	10		●	4	84,0	4545	
236	3	●	4	12,0	3020	12		●	4	86,0	5050	
	4	●	4	17,2	3535	375		3	x	7	23,8	3535
	5	●	4	19,1	3535			4	x	10	30,0	3535
	6	●	4	20,8	3535			5	x	10	33,0	3535
	8	●	4	25,5	3535			6	x	10	45,5	4040
250	3	●	4	14,5	3020			8	x	10	68,0	4545
	4	●	4	20,7	3535		10	○	9	88,0	4545	
	5	●	4	22,8	3535		12	●	4	92,0	5050	
	6	●	4	26,0	3535		400	3	x	7	24,1	3535
	8	●	4	29,7	3535			4	x	10	28,0	3535
	10	●	4	34,0	4040			5	x	10	34,0	3535
265	3	●	8	21,2	3535			6	x	10	48,0	4040
	4	●	4	24,0	3535			8	x	10	65,0	4545
	5	●	4	31,2	3535	10		○	9	88,0	5050	
	6	●	4	29,0	3535	12		○	9	98,0	5050	
	8	●	4	33,3	3535	425		3	x	7	26,0	3535
280	3	●	8	24,0	3535			4	x	10	31,0	3535
	4	○	9	29,0	3535			5	x	10	45,0	3535
	5	○	9	31,0	3535			6	x	10	58,0	4040
	6	○	9	33,8	3535			8	x	10	74,0	4545
	8	●	4	37,5	3535		10	○	9	96,0	5050	
	10	●	4	45,0	4040		12	○	9	100,0	5050	
300	3	x	7	21,0	3535		450	3	x	7	28,6	3535
	4	○	9	25,0	3535			4	x	10	33,5	3535
	5	○	9	28,5	3535			5	x	10	45,0	4040
	6	○	9	29,0	3535			6	x	10	61,1	4545
	8	●	4	46,5	4040			8	x	10	78,7	5050
	10	●	4	53,5	4545	10		x	10	101,0	5050	
315	3	x	7	21,6	3535	12		○	9	113,0	5050	
	4	x	10	24,6	3535	475		3	x	7	40,0	3535
	5	x	10	29,0	3535			4	x	10	47,0	3535
	6	x	10	31,4	3535			5	x	10	47,2	4040
	8	●	4	50,0	4040			6	x	10	62,8	4545
	10	●	4	58,0	4545			8	x	10	81,5	5050
	12	●	4	69,0	5050		10	x	10	90,0	5050	
							12	○	9	120,0	5050	

Richtdurchmesser d_1 (mm)	Anzahl der Rillen	Ausführung	Ausführungs Nr.	Gewicht ohne Buchse (kg)	Taper buchse						
500	3	x	7	30,9	3535						
	4	x	10	39,0	3535						
	5	x	10	48,7	4040						
	6	x	10	60,2	4545						
	8	x	10	87,4	5050						
	10	x	10	105,0	5050						
560	12	○	9	127,0	5050						
	3	x	7	36,0	3535						
	4	x	10	50,0	4040						
	5	x	10	63,0	4545						
	6	x	10	77,0	5050						
	8	x	10	94,0	5050						
	10	x	10	115,0	5050						
630	12	x	10	145,0	5050						
	3	x	7	48,5	4040						
	4	x	7	61,0	4545						
	5	x	10	77,0	5050						
	6	x	10	86,0	5050						
	8	x	10	105,5	5050						
	10	x	10	130,0	5050						
710	12	x	10	160,0	5050						
	3*	x	7	62,5	4040						
	4*	x	7	78,6	5050						
	5	x	10	89,6	5050						
	6	x	10	99,4	5050						
	8	x	10	117,5	5050						
	10	x	10	137,1	5050						
800	12	x	10	170,0	5050						
	3*	x	7	72,0	4545						
	4*	x	7	90,8	5050						
	5	x	10	102,5	5050						
	6	x	10	113,7	5050						
	8	x	10	136,6	5050						
	10	x	10	160,7	5050						
1000	12	x	10	220,0	5050						
	5	x	10	134,0	5050						
	6	x	10	150,0	5050						
	8	x	10	181,4	5050						
	10	x	10	217,2	5050						
1250	12*	x	10	270,0	5050						
	5	x	10	177,6	5050						
	6	x	10	201,4	5050						
	8	x	10	243,7	5050						
	10	x	10	292,1	5050						
	12	x	10	310,0	5050						

Anzahl der Rillen	2	3	4	5	6	8	10
Kranzbreite b_2 (mm)	59,5	85	110,5	136	161,5	212,5	263,5

Taper-Buchse	2517	3020	3535	4040	4545	5050
Bohrung d_2 (mm) von ... bis ...	16-65	25-75	35-90	40-100	55-110	70-125

● Vollscheibe ○ Bodenscheibe (mit oder ohne Spiegel) x Armscheibe
 Material: EN-GJL 200
 * Keine Lagerware
 Bohrungsdurchmesser d_2 siehe Seite 4

Fertigungstechnische Änderungen vorbehalten.

Richtdurchmesser d ₂ (mm)	Anzahl der Rillen	Ausführung	Gewicht (kg)	Fertigbohrung d _{max} (mm)	Nabenlänge l (mm)	Richtdurchmesser d ₂ (mm)	Anzahl der Rillen	Ausführung	Gewicht (≈kg)	Fertigbohrung d _{max} (mm)	Nabenlänge l (mm)
SPZ/10											
45▲	1	○	0,200	16	24	140	1	○	0,900	28	24
	2	○	0,300	16	35		2	○	1,400	38	38
	3	○	0,400	16	35		3	○	1,700	38	40
50▲	1	○	0,300	20	24	150	1	x	1,100	28	24
	2	○	0,400	20	35		2	○	1,500	38	38
	3	○	0,500	20	40		3	○	1,900	38	40
56▲	1	○	0,300	20	24	160	1	x	1,200	32	30
	2	○	0,500	25	35		2	x	1,600	38	38
	3	○	0,700	25	40		3	x	2,400	42	40
63	1	○	0,300	25	24	170	1	x	1,700	40	30
	2	○	0,600	25	35		2	x	1,900	40	38
	3	○	0,900	25	40		3	x	3,000	42	40
71	1	○	0,300	25	24	180	1	x	2,100	32	30
	2	○	0,600	25	35		2	x	3,100	38	38
	3	○	1,000	30	40		3	x	3,500	42	40
75	1	○	0,400	24	24	190	1	x	2,300	35	30
	2	○	0,600	24	35		2	x	2,400	35	38
	3	○	1,100	28	40		3	x	4,000	35	40
80	1	○	0,400	25	24	200	1	x	2,400	32	38
	2	○	0,700	30	35		2	x	2,900	38	38
	3	○	1,100	38	35		3	x	4,500	42	40
85	1	○	0,300	25	24	212	1	x	2,600	35	30
	2	○	0,700	30	35		2	x	3,400	35	38
	3	○	1,100	38	35		3	x	5,000	38	40
90	1	○	0,400	25	24	225	1	x	2,800	32	38
	2	○	0,800	30	35		2	x	4,000	38	38
	3	○	1,200	38	38		3	x	5,300	42	40
95	1	○	0,400	28	24	250	1	x	3,300	32	38
	2	○	0,800	28	35		2	x	4,800	38	38
	3	○	1,200	38	38		3	x	6,000	42	40
100	1	○	0,500	28	24	280	1	x	3,900	35	34
	2	○	0,900	30	35		2	x	5,200	42	38
	3	○	1,300	38	38		3	x	7,000	48	40
106	1	○	0,500	30	24	315	1	x	4,400	35	34
	2	○	1,000	28	35		2	x	6,800	42	38
	3	○	1,300	38	38		3	x	8,300	48	40
112	1	○	0,500	28	24	355	1	x	4,600	35	34
	2	○	1,000	30	35		2	x	8,000	42	40
	3	○	1,400	38	38		3	x	10,000	48	45
118	1	○	0,600	28	24						
	2	○	1,100	38	35						
	3	○	1,500	38	38						
125	1	○	0,700	28	24						
	2	○	1,200	38	35						
	3	○	1,600	38	40						
132	1	○	0,800	30	24						
	2	○	1,300	38	35						
	3	○	1,600	40	40						

Anzahl der Rillen	1	2	3
Kranzbreite b ₂ (mm)	16	28	40

● Vollscheibe ○ Bodenscheibe (mit oder ohne Spiegel) x Armscheibe
▲ nur für Profil 10
Nabenlage: einseitig bündig
Material: EN-GJL 200

Fertigungstechnische Änderungen vorbehalten.

Richtdurchmesser d _d (mm)	Anzahl der Rillen	Ausfüh- rung	Gewicht (≈kg)	Fertigboh- rung d _{max} (mm)	Nabenlän- ge l (mm)	Richtdurchmesser d _d (mm)	Anzahl der Rillen	Ausfüh- rung	Gewicht (≈kg)	Fertigboh- rung d _{max} (mm)	Nabenlän- ge l (mm)
SPA/13											
50▲	1	○	0,300	18	34	106	1	○	0,900	28	34
	2	○	0,500	18	49		2	○	1,700	28	49
	3	○	0,600	18	47		3	○	2,200	32	42
56▲	1	○	0,400	20	34		4	○	3,200	32	53
	2	○	0,600	20	49		5	○	3,900	35	60
63▲	1	○	0,500	25	34	112	1	○	1,100	28	34
	2	○	0,800	25	49		2	○	1,800	38	49
	3	○	0,900	25	47		3	○	2,400	38	42
	4	○	1,200	25	60		4	○	3,400	42	53
5	○	1,500	25	70	5		○	4,000	42	60	
71▲	1	○	0,500	25	34	118	1	○	1,100	32	34
	2	○	0,900	28	49		2	○	1,800	38	49
	3	○	1,000	32	42		3	○	2,400	42	42
	4	○	1,500	32	60		4	○	3,400	42	53
5	○	1,800	32	70	5		○	4,100	48	65	
75▲	1	○	0,500	24	34	125	1	○	1,400	32	34
	2	○	1,000	24	49		2	○	1,900	38	49
	3	○	1,100	24	42		3	○	2,600	42	42
	4	○	1,800	24	60		4	○	3,500	42	53
	5	○	1,900	28	82		5	○	4,400	48	65
80▲	1	○	0,600	28	34	132	1	○	1,500	32	34
	2	○	1,000	32	49		2	○	2,200	38	49
	3	○	1,200	38	42		3	○	2,600	42	42
	4	○	1,900	38	60		4	○	3,600	42	53
	5	○	2,000	38	55		5	○	4,800	48	65
85	1	○	0,600	24	34	140	1	○	1,500	32	34
	2	○	1,200	28	49		2	○	2,300	38	49
	3	○	1,400	28	42		3	○	2,600	42	42
	4	○	2,000	28	53		4	○	3,700	42	53
	5	○	2,200	32	55		5	○	5,000	48	65
90	1	○	0,900	28	34	150	1	x	1,600	38	36
	2	○	1,500	32	49		2	x	2,600	38	49
	3	○	1,600	38	42		3	○	3,000	42	42
	4	○	2,200	42	53		4	○	4,000	42	53
	5	○	2,500	42	67		5	○	5,200	48	65
95	1	○	0,800	28	34	160	1	x	1,800	38	36
	2	○	1,600	28	49		2	x	2,400	38	49
	3	○	1,900	28	42		3	x	2,800	42	42
	4	○	2,500	32	53		4	○	3,600	48	60
	5	○	2,800	35	67		5	○	5,500	48	70
100	1	○	0,800	28	34	170	1	x	2,000	35	36
	2	○	1,400	32	49		2	x	2,900	35	49
	3	○	2,000	38	42		3	x	3,200	35	42
	4	○	2,700	42	53		4	x	4,200	35	60
	5	○	3,100	42	60		5	x	5,800	38	70
						180	1	x	2,000	38	36
							2	x	3,200	42	49
							3	x	3,600	42	42
							4	x	4,700	48	60
							5	x	6,100	48	70

Richtdurchmesser d _j (mm)	Anzahl der Rillen	Ausführung	Gewicht (≈kg)	Fertigbohrung d _{max} (mm)	Nabenlänge l (mm)	Richtdurchmesser d _j (mm)	Anzahl der Rillen	Ausführung	Gewicht (≈kg)	Fertigbohrung d _{max} (mm)	Nabenlänge l (mm)
190	1	x	2,000	38	36	400	1	x	6,900	50	50
	2	x	3,200	42	49		2	x	8,800	55	53
	3	x	4,000	42	42		3	x	10,500	60	47
	4	x	5,200	48	60		4	x	12,400	60	67
	5	x	6,300	48	70		5	x	15,900	60	82
200	1	x	2,400	38	36	450	1	x	7,500	55	50
	2	x	2,900	42	49		2	x	9,400	55	53
	3	x	4,200	48	42		3	x	12,200	60	47
	4	x	5,000	55	60		4	x	14,200	65	67
	5	x	6,500	55	70		5	x	18,300	65	82
212	1	x	2,700	40	36	500	1	x	10,500	55	50
	2	x	3,400	42	49		2	x	10,700	55	55
	3	x	4,400	42	42		3	x	13,500	60	60
	4	x	5,700	42	60		4	x	16,300	65	67
	5	x	6,900	42	70		5	x	22,800	65	82
225	1	x	2,800	40	36	560	1	x	14,000	55	60
	2	x	3,900	42	49		2	x	13,100	55	60
	3	x	4,600	42	42		3	x	15,600	60	74
	4	x	6,500	42	60		4	x	19,400	65	67
	5	x	7,300	42	70		5	x	24,500	65	82
236	1	x	3,300	38	36						
	2	x	4,100	42	49						
	3	x	4,900	48	47						
	4	x	6,200	55	60						
	5	x	7,500	55	70						
250	1	x	3,400	42	36						
	2	x	4,300	48	49						
	3	x	5,300	48	47						
	4	x	7,000	55	60						
	5	x	7,900	60	70						
280	1	x	3,900	42	44						
	2	x	5,400	48	53						
	3	x	6,500	48	47						
	4	x	8,500	55	60						
	5	x	9,900	60	70						
300	1	x	4,300	48	44						
	2	x	5,900	48	53						
	3	x	7,500	55	47						
	4	x	9,800	55	60						
	5	x	11,300	60	70						
315	1	x	4,800	48	44						
	2	x	6,600	48	53						
	3	x	8,800	55	47						
	4	x	11,100	55	60						
	5	x	10,500	60	70						
355	1	x	5,500	48	44						
	2	x	7,700	55	53						
	3	x	9,600	55	47						
	4	x	11,800	55	60						
	5	x	13,800	60	70						

Anzahl an Rillen	1	2	3	4	5
Kranzbreite b ₂ (mm)	20	35	50	67	82

● Vollscheibe ○ Bodenscheibe (mit oder ohne Spiegel) x Armscheibe
▲ nur für Profil 13
Nabenlage: einseitig bündig
Material: EN-GJL 200

Fertigungstechnische Änderungen vorbehalten.

Richtdurchmesser d _d (mm)	Anzahl der Rillen	Ausführung	Gewicht (≈kg)	Fertigbohrung d _{max} (mm)	Nabellänge l (mm)	Richtdurchmesser d _d (mm)	Anzahl der Rillen	Ausführung	Gewicht (≈kg)	Fertigbohrung d _{max} (mm)	Nabellänge l (mm)
SPB/17											
56▲	1	○	0,600	20	41	118▲	1	○	1,600	32	41
	2	○	1,000	20	60		2	○	2,400	38	60
	3	○	1,100	22	62		3	○	3,200	42	55
63▲	1	○	0,800	20	41		4	○	5,200	42	70
	2	○	1,200	20	60		5	○	7,200	42	75
	3	○	1,200	22	62		6	○	6,600	42	85
71▲	1	○	0,800	22	41	125▲	1	○	1,700	32	41
	2	○	1,300	22	60		2	○	2,600	38	60
	3	○	1,600	22	55		3	○	3,300	42	55
75▲	1	○	0,800	25	41		4	○	4,700	42	70
	2	○	1,400	25	60		5	○	8,600	42	75
	3	○	1,900	25	62		6	○	8,000	48	85
80▲	1	○	1,000	28	41	132▲	1	○	1,900	30	41
	2	○	1,700	28	60		2	○	2,600	30	60
	3	○	2,100	28	55		3	○	3,500	42	55
	4	○	2,400	28	70		4	○	6,300	42	70
	5	○	2,700	28	80		5	○	9,400	42	75
6	○	2,700	28	80	6		○	8,500	42	85	
85▲	1	○	1,100	30	41	140	1	○	2,100	32	41
	2	○	1,700	30	60		2	○	2,900	38	60
	3	○	2,200	30	55		3	○	3,900	42	55
	4	○	2,700	30	70		4	○	6,900	42	70
	5	○	3,000	30	75		5	○	7,600	48	75
6	○	3,000	30	75	6		○	11,400	48	85	
90▲	1	○	1,200	32	41	150	1	○	2,400	32	43
	2	○	1,800	38	60		2	○	3,200	38	48
	3	○	2,300	38	55		3	○	4,300	42	60
	4	○	3,100	38	70		4	○	6,800	42	70
	5	○	3,300	38	75		5	○	8,400	48	75
6	○	3,300	38	75	6		○	12,100	48	85	
95▲	1	○	1,300	35	41	160	1	x	2,500	38	43
	2	○	2,000	38	60		2	x	3,300	42	48
	3	○	2,500	38	67		3	x	4,600	48	60
	4	○	2,900	38	70		4	○	7,000	48	70
	5	○	3,600	38	75		5	○	9,400	48	75
6	○	3,600	38	75	6		○	12,900	55	85	
100▲	1	○	1,300	32	41	170	1	x	2,900	42	43
	2	○	2,100	38	60		2	x	3,400	42	48
	3	○	2,900	38	55		3	x	4,900	42	60
	4	○	3,800	38	70		4	○	7,200	48	70
	5	○	4,500	38	75		5	○	8,900	48	75
	6	○	5,200	38	124		6	○	13,100	48	85
106▲	1	○	1,500	28	41	180	1	x	3,100	38	43
	2	○	2,000	28	60		2	x	3,900	42	48
	3	○	3,000	30	55		3	x	5,300	48	60
	4	○	4,300	30	70		4	x	7,400	48	70
	5	○	5,100	32	75		5	○	9,100	55	75
	6	○	6,000	32	124		6	○	10,800	60	85
112▲	1	○	1,500	32	41						
	2	○	2,400	38	60						
	3	○	3,100	38	55						
	4	○	4,800	42	67						
	5	○	5,600	42	75						
	6	○	6,200	42	85						

Richtdurchmesser d _d (mm)	Anzahl der Rillen	Ausführung	Gewicht (≈kg)	Fertigbohrung d _{max} (mm)	Nabenlänge l (mm)	Richtdurchmesser d _d (mm)	Anzahl der Rillen	Ausführung	Gewicht (≈kg)	Fertigbohrung d _{max} (mm)	Nabenlänge l (mm)
190	1	x	3,200	42	43	355	1	x	7,000	48	49
	2	x	4,200	42	48		2	x	9,700	55	55
	3	x	5,500	42	60		3	x	13,400	55	67
	4	x	7,700	48	70		4	x	18,300	60	80
	5	○	9,200	50	75		5	x	18,800	65	75
	6	○	12,000	55	85		6	x	19,800	75	90
200	1	x	3,400	38	43	400	1	x	8,500	50	49
	2	x	4,500	42	48		2	x	10,000	55	55
	3	x	5,900	48	60		3	x	14,300	60	67
	4	x	8,000	50	60		4	x	18,500	65	80
	5	○	9,500	55	80		5	x	22,500	70	85
	6	○	12,200	60	90		6	x	28,000	75	90
212	1	x	3,800	42	43	450	1	x	9,900	50	55
	2	x	4,700	42	48		2	x	10,900	55	55
	3	x	6,200	48	60		3	x	15,100	60	67
	4	x	7,700	50	70		4	x	20,500	65	80
	5	x	10,300	50	80		5	x	26,000	70	80
	6	○	13,500	55	90		6	x	28,900	75	90
225	1	x	4,000	42	43	500	1	x	10,700	50	55
	2	x	5,400	42	48		2	x	13,700	60	59
	3	x	6,900	48	60		3	x	15,200	65	67
	4	x	8,600	55	70		4	x	21,300	70	80
	5	○	11,700	50	90		5	x	30,000	75	80
	6	○	14,800	55	90		6	x	33,800	80	90
250	1	x	4,200	42	43	560	2	x	15,000	60	55
	2	x	6,100	48	55		3	x	24,200	65	67
	3	x	8,600	55	60		4	x	26,000	70	80
	4	x	9,800	60	70		5	x	34,400	75	80
	5	x	13,200	65	80		6	x	39,000	80	90
	6	x	17,000	65	90		2	x	20,200	60	80
280	1	x	5,700	48	49	630	3	x	27,000	65	80
	2	x	7,000	48	55		4	x	30,800	75	86
	3	x	9,700	55	60		5	x	37,200	80	90
	4	x	11,500	60	70		6	x	44,000	90	100
	5	x	15,500	65	80						
	6	x	18,000	65	90						
300	1	x	5,900	48	49						
	2	x	7,500	48	55						
	3	x	10,500	55	67						
	4	x	12,400	60	80						
	5	x	16,500	65	80						
	6	x	18,300	70	90						
315	1	x	6,400	48	49						
	2	x	8,200	55	55						
	3	x	12,900	55	67						
	4	x	13,000	60	80						
	5	x	17,600	65	80						
	6	x	20,600	75	90						

Anzahl der Rillen	1	2	3	4	5	6
Kranzbreite b ₂ (mm)	25	44	63	86	105	124

● Vollscheibe ○ Bodenscheibe (mit oder ohne Spiegel) x Armscheibe
 ▲ nur für Profil 17
 Nabennlage: einseitig bündig
 Material: EN-GJL 200

Fertigungstechnische Änderungen vorbehalten.

Richtdurchmesser d _d (mm)	Anzahl der Rillen	Ausführung	Gewicht (=kg)	Fertigbohrung d _{max} (mm)	Nabenlänge l (mm)	Richtdurchmesser d _d (mm)	Anzahl der Rillen	Ausführung	Gewicht (=kg)	Fertigbohrung d _{max} (mm)	Nabenlänge l (mm)
SPC/22											
180	1*	○	4,200	40	54	450	2*	x	21,100	70	80
	2*	○	7,200	50	64		3*	x	26,300	75	90
	3*	○	10,400	55	90		4*	x	31,100	75	105
	4*	○	10,500	55	95		5*	x	42,200	80	110
	5*	○	18,000	60	100		6*	x	48,500	80	120
	6*	○	23,600	65	115						
200	1*	○	4,800	40	54	500	3*	x	28,400	75	90
	2*	○	7,800	50	64		4*	x	34,100	75	105
	3*	○	8,800	55	90		5*	x	48,200	80	110
	4*	○	11,200	60	95		6*	x	52,500	80	120
	5*	○	15,400	65	100						
	6*	○	27,000	70	125						
225	1*	x	5,500	48	54	560	3*	x	31,100	75	90
	2*	x	7,800	52	64		4*	x	39,000	75	105
	3*	x	10,600	52	90		5*	x	54,100	80	110
	4*	x	13,100	55	95		6*	x	61,500	85	120
	5*	x	16,700	60	100						
	6*	x	35,000	60	115						
250	1*	x	7,300	52	54	630	3*	x	38,500	80	90
	2*	x	8,800	52	64		4*	x	48,100	80	105
	3*	x	11,000	65	90		5*	x	62,200	85	110
	4*	x	15,300	70	95		6*	x	73,200	85	120
	5*	x	19,000	75	100						
	6*	x	23,700	60	115						
280	1*	x	8,700	52	54						
	2*	x	10,900	55	64						
	3*	x	15,600	70	90						
	4*	x	17,500	75	95						
	5*	x	20,500	75	100						
	6*	x	20,500	75	100						
315	1*	x	9,100	52	54						
	2*	x	13,000	55	74						
	3*	x	17,100	70	90						
	4*	x	20,000	75	95						
	5*	x	24,700	80	100						
	6*	x	31,200	85	115						
335	2*	x	14,000	55	74						
	3*	x	18,300	55	90						
	4*	x	22,400	60	95						
	5*	x	28,300	65	100						
	6*	x	34,400	75	115						
355	2*	x	15,200	60	74						
	3*	x	19,200	70	90						
	4*	x	25,800	70	95						
	5*	x	32,000	75	100						
	6*	x	36,200	75	115						
400	3*	x	20,600	70	90						
	4*	x	28,000	70	105						
	5*	x	32,000	75	100						

Anzahl der Rillen	1	2	3	4	5	6
Kranzbreite b ₂ (mm)	38	64	90	116	142	168

● Vollscheibe ○ Bodenscheibe (mit oder ohne Spiegel) x Armscheibe
 * Keine Lagerware
 Nabenhöhe: einseitig bündig
 Material: EN-GJL 200

Fertigungstechnische Änderungen vorbehalten.



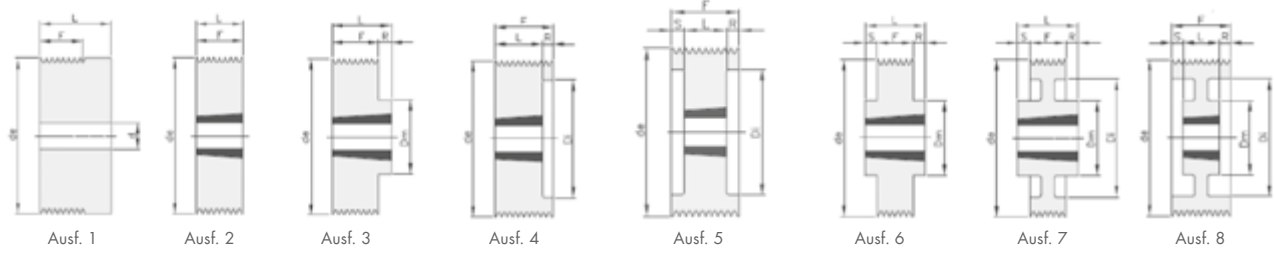

Bezeichnung	Anzahl der Rillen	Ausführung	Max. Bohrung	Material	D _m (mm)	D _i (mm)	F (mm)	L (mm)	R (mm)	S (mm)	Taper buchse	
8PJ												
TB 8 PJ 56	8	2	28,00	GG	-	-	23,0	23,0	-	-	1108	
TB 8 PJ 63	8	2	28,00	GG	-	-	23,0	23,0	-	-	1108	
TB 8 PJ 71	8	2	28,00	GG	-	-	23,0	23,0	-	-	1108	
TB 8 PJ 75	8	2	28,00	GG	-	-	23,0	23,0	-	-	1108	
TB 8 PJ 80	8	3	42,00	GG	70,0	-	23,0	26,0	3,0	-	1610	
TB 8 PJ 85	8	3	42,00	GG	70,0	-	23,0	26,0	3,0	-	1610	
TB 8 PJ 90	8	3	42,00	GG	70,0	-	23,0	26,0	3,0	-	1610	
TB 8 PJ 95	8	3	42,00	GG	82,0	-	23,0	26,0	3,0	-	1610	
TB 8 PJ 100	8	3	42,00	GG	82,0	-	23,0	26,0	3,0	-	1610	
TB 8 PJ 106	8	3	42,00	GG	82,0	-	23,0	26,0	3,0	-	1610	
TB 8 PJ 112	8	3	42,00	GG	90,0	-	23,0	26,0	3,0	-	1610	
TB 8 PJ 118	8	3	42,00	GG	90,0	-	23,0	26,0	3,0	-	1610	
TB 8 PJ 125	8	3	42,00	GG	90,0	-	23,0	26,0	3,0	-	1610	
TB 8 PJ 132	8	3	42,00	GG	90,0	-	23,0	26,0	3,0	-	1610	
TB 8 PJ 140	8	3	42,00	GG	90,0	-	23,0	26,0	3,0	-	1610	
TB 8 PJ 160	8	6	50,00	GG	110,0	-	23,0	32,0	4,5	4,5	2012	
TB 8 PJ 180	8	6	50,00	GG	110,0	-	23,0	32,0	4,5	4,5	2012	
TB 8 PJ 190	8	6	50,00	GG	110,0	-	23,0	32,0	4,5	4,5	2012	
TB 8 PJ 200	8	6	50,00	GG	110,0	-	23,0	32,0	4,5	4,5	2012	
TB 8 PJ 212	8	6	50,00	GG	110,0	-	23,0	32,0	4,5	4,5	2012	
TB 8 PJ 224	8	6	50,00	GG	110,0	-	23,0	32,0	4,5	4,5	2012	
TB 8 PJ 250	8	6	50,00	GG	110,0	-	23,0	32,0	4,5	4,5	2012	
TB 8 PJ 280	8	7	50,00	GG	110,0	260,0	23,0	32,0	4,5	4,5	2012	
TB 8 PJ 315	8	7	50,00	GG	110,0	295,0	23,0	32,0	4,5	4,5	2012	
12PJ												
TB 12 PJ 63	12	4	28,00	GG	-	46,0	32,5	23,0	9,5	-	1108	
TB 12 PJ 71	12	4	28,00	GG	-	46,0	32,5	23,0	9,5	-	1108	
TB 12 PJ 75	12	4	42,00	GG	-	60,0	32,5	26,0	6,5	-	1610	
TB 12 PJ 80	12	4	42,00	GG	-	60,0	32,5	26,0	6,5	-	1610	
TB 12 PJ 85	12	4	42,00	GG	-	60,0	32,5	26,0	6,5	-	1610	
TB 12 PJ 90	12	4	42,00	GG	-	74,0	32,5	26,0	6,5	-	1610	
TB 12 PJ 95	12	4	42,00	GG	-	74,0	32,5	26,0	6,5	-	1610	
TB 12 PJ 100	12	4	42,00	GG	-	74,0	32,5	26,0	6,5	-	1610	
TB 12 PJ 106	12	4	42,00	GG	-	88,0	32,5	26,0	6,5	-	1610	
TB 12 PJ 112	12	4	42,00	GG	-	88,0	32,5	26,0	6,5	-	1610	
TB 12 PJ 118	12	4	50,00	GG	-	98,0	32,5	32,0	0,5	-	2012	
TB 12 PJ 125	12	4	50,00	GG	-	98,0	32,5	32,0	0,5	-	2012	
TB 12 PJ 132	12	4	65,00	GG	-	98,0	32,5	32,0	0,5	-	2012	
TB 12 PJ 140	12	3	65,00	GG	120,0	-	32,5	45,0	12,5	-	2517	
TB 12 PJ 160	12	3	65,00	GG	120,0	-	32,5	45,0	12,5	-	2517	
TB 12 PJ 180	12	6	65,00	GG	120,0	-	32,5	45,0	6,25	6,25	2517	
TB 12 PJ 190	12	6	65,00	GG	120,0	-	32,5	45,0	6,25	6,25	2517	
TB 12 PJ 200	12	6	65,00	GG	120,0	-	32,5	45,0	6,25	6,25	2517	
TB 12 PJ 212	12	6	65,00	GG	120,0	-	32,5	45,0	6,25	6,25	2517	

Bezeichnung	Anzahl der Rillen	Ausführung	Max. Bohrung	Material	D _m (mm)	D _i (mm)	F (mm)	L (mm)	R (mm)	S (mm)	Taper Buchse	
TB 12 PJ 224	12	6	65,00	GG	120,0	-	32,5	45,0	6,25	6,25	2517	
TB 12 PJ 250	12	6	65,00	GG	120,0	-	32,5	45,0	6,25	6,25	2517	
TB 12 PJ 280	12	7	65,00	GG	120,0	260,0	32,5	45,0	6,25	6,25	2517	
TB 12 PJ 315	12	7	65,00	GG	120,0	295,0	32,5	45,0	6,25	6,25	2517	
16PJ												
TB 16 PJ 71	16	2	32,00	GG	-	55,0	42,0	42,0	-	-	1215	
TB 16 PJ 75	16	4	42,00	GG	-	60,0	42,0	26,0	16,0	-	1610	
TB 16 PJ 80	16	4	42,00	GG	-	60,0	42,0	26,0	16,0	-	1610	
TB 16 PJ 85	16	4	42,00	GG	-	60,0	42,0	26,0	16,0	-	1610	
TB 16 PJ 90	16	4	42,00	GG	-	74,0	42,0	26,0	16,0	-	1610	
TB 16 PJ 95	16	4	42,00	GG	-	74,0	42,0	26,0	16,0	-	1610	
TB 16 PJ 100	16	4	42,00	GG	-	74,0	42,0	26,0	16,0	-	1610	
TB 16 PJ 106	16	4	42,00	GG	-	88,0	42,0	26,0	16,0	-	1610	
TB 16 PJ 112	16	4	42,00	GG	-	88,0	42,0	26,0	16,0	-	1610	
TB 16 PJ 118	16	4	50,00	GG	-	98,0	42,0	32,0	10,0	-	2012	
TB 16 PJ 125	16	4	50,00	GG	-	98,0	42,0	32,0	10,0	-	2012	
TB 16 PJ 132	16	4	50,00	GG	-	98,0	42,0	32,0	10,0	-	2012	
TB 16 PJ 140	16	3	65,00	GG	120,0	-	42,0	45,0	3,0	-	2517	
TB 16 PJ 160	16	3	65,00	GG	120,0	-	42,0	45,0	3,0	-	2517	
TB 16 PJ 180	16	6	65,00	GG	120,0	-	42,0	45,0	1,5	1,5	2517	
TB 16 PJ 190	16	6	65,00	GG	120,0	-	42,0	45,0	1,5	1,5	2517	
TB 16 PJ 200	16	6	65,00	GG	120,0	-	42,0	45,0	1,5	1,5	2517	
TB 16 PJ 212	16	6	65,00	GG	120,0	-	42,0	45,0	1,5	1,5	2517	
TB 16 PJ 224	16	6	65,00	GG	120,0	-	42,0	45,0	1,5	1,5	2517	
TB 16 PJ 250	16	6	65,00	GG	120,0	-	42,0	45,0	1,5	1,5	2517	
TB 16 PJ 280	16	7	65,00	GG	120,0	260,0	42,0	45,0	1,5	1,5	2517	
TB 16 PJ 315	16	7	65,00	GG	120,0	295,0	42,0	45,0	1,5	1,5	2517	
8PL												
TB 8 PL 90	8	4	42,00	GG	-	66,0	48,0	26,0	22,0	-	1108	
TB 8 PL 95	8	4	42,00	GG	-	71,0	48,0	26,0	22,0	-	1108	
TB 8 PL 106	8	4	42,00	GG	-	82,0	48,0	26,0	22,0	-	1108	
TB 8 PL 112	8	4	42,00	GG	-	88,0	48,0	26,0	16,0	-	1610	
TB 8 PL 125	8	4	50,00	GG	-	101,0	48,0	32,0	16,0	-	1610	
TB 8 PL 132	8	4	50,00	GG	-	108,0	48,0	32,0	16,0	-	1610	
TB 8 PL 140	8	4	65,00	GG	-	116,0	48,0	45,0	3,0	-	1610	
TB 8 PL 150	8	4	65,00	GG	-	126,0	48,0	45,0	3,0	-	1610	
TB 8 PL 160	8	4	65,00	GG	-	136,0	48,0	45,0	3,0	-	1610	
TB 8 PL 170	8	4	65,00	GG	-	146,0	48,0	45,0	3,0	-	1610	
TB 8 PL 180	8	8	65,00	GG	120,0	156,0	48,0	45,0	1,5	1,5	1610	
TB 8 PL 190	8	8	65,00	GG	120,0	166,0	48,0	45,0	1,5	1,5	1610	
TB 8 PL 200	8	8	65,00	GG	120,0	176,0	48,0	45,0	1,5	1,5	2012	
TB 8 PL 212	8	8	65,00	GG	120,0	188,0	48,0	45,0	1,5	1,5	2012	
TB 8 PL 224	8	8	65,00	GG	120,0	202,0	48,0	45,0	1,5	1,5	2012	
TB 8 PL 250	8	7	75,00	GG	146,0	228,0	48,0	52,0	2,0	2,0	2012	
TB 8 PL 280	8	7	75,00	GG	146,0	256,0	48,0	52,0	2,0	2,0	2012	
TB 8 PL 315	8	7	75,00	GG	146,0	285,0	48,0	52,0	2,0	2,0	2012	
12PL												
TB 12 PL 75	12	4	32,00	GG	-	56,0	67,0	42,0	25,0	-	1215	
TB 12 PL 80	12	4	32,00	GG	-	56,0	67,0	42,0	25,0	-	1215	
TB 12 PL 85	12	4	32,00	GG	-	61,0	67,0	42,0	25,0	-	1215	
TB 12 PL 90	12	4	42,00	GG	-	66,0	67,0	42,0	25,0	-	1615	
TB 12 PL 95	12	4	42,00	GG	-	71,0	67,0	42,0	25,0	-	1615	

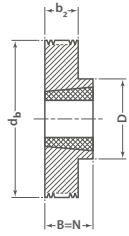

Ausf. 1

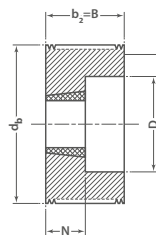

Ausf. 2

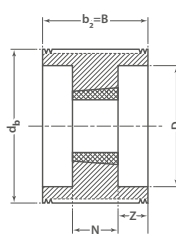

Ausf. 3

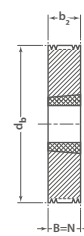

Ausf. 4

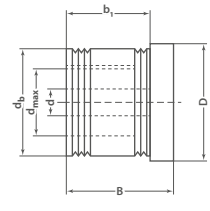

Ausf. VB

Bezeichnung	Anzahl der Rillen	Ausführung	Material	d_b (mm)	b_2 (mm)	B (mm)	N (mm)	D (mm)	Taperbuche
4PJ									
TB 4 PJ 47,5	4	1	GG	47,5	13	23	23	47,5	1008
TB 4 PJ 52,5	4	1	GG	52,5	13	23	23	47,5	1008
TB 4 PJ 57,5	4	1	GG	57,5	13	23	23	54,0	1108
TB 4 PJ 62,5	4	1	GG	62,5	13	23	23	54,0	1108
TB 4 PJ 67,5	4	1	GG	67,5	13	23	23	54,0	1108
TB 4 PJ 72,5	4	1	GG	72,5	13	23	23	54,0	1108
TB 4 PJ 77,5	4	1	GG	77,5	13	26	26	70,0	1210
TB 4 PJ 82,5	4	1	GG	82,5	13	26	26	78,0	1210
TB 4 PJ 87,5	4	1	GG	87,5	13	26	26	78,0	1210
TB 4 PJ 92,5	4	1	GG	92,5	13	26	26	78,0	1210
TB 4 PJ 97,5	4	1	GG	97,5	13	26	26	78,0	1210
TB 4 PJ 102,5	4	1	GG	102,5	13	26	26	85,0	1610
TB 4 PJ 107,5	4	1	GG	107,5	13	26	26	85,0	1610
TB 4 PJ 112,5	4	1	GG	112,5	13	26	26	85,0	1610
TB 4 PJ 117,5	4	1	GG	117,5	13	26	26	85,0	1610
TB 4 PJ 122,5	4	1	GG	122,5	13	26	26	85,0	1610
TB 4 PJ 127,5	4	1	GG	127,5	13	26	26	85,0	1610
TB 4 PJ 137,5	4	1	GG	137,5	13	26	26	85,0	1610
TB 4 PJ 152,5	4	1	GG	152,5	13	26	26	85,0	1610
TB 4 PJ 162,5	4	1	GG	162,5	13	26	26	85,0	1610
TB 4 PJ 172,5	4	1	GG	172,5	13	26	26	85,0	1610
TB 4 PJ 182,5	4	1	GG	182,5	13	26	26	85,0	1610
TB 4 PJ 192,5	4	1	GG	192,5	13	26	26	85,0	1610
TB 4 PJ 202,5	4	1	GG	202,5	13	33	33	100,0	2012
TB 4 PJ 222,5	4	1	GG	222,5	13	33	33	100,0	2012
8PJ									
TB 8 PJ 47,5	8	4	GG	47,5	23	23	23	-	1008
TB 8 PJ 52,5	8	4	GG	52,5	23	23	23	-	1008
TB 8 PJ 57,5	8	4	GG	57,5	23	23	23	-	1108
TB 8 PJ 62,5	8	4	GG	62,5	23	23	23	-	1108
TB 8 PJ 67,5	8	4	GG	67,5	23	23	23	-	1108
TB 8 PJ 72,5	8	4	GG	72,5	23	23	23	-	1108
TB 8 PJ 77,5	8	1	GG	77,5	23	26	26	70	1210
TB 8 PJ 82,5	8	1	GG	82,5	23	26	26	78	1210
TB 8 PJ 87,5	8	1	GG	87,5	23	26	26	78	1210
TB 8 PJ 92,5	8	1	GG	92,5	23	26	26	78	1210
TB 8 PJ 97,5	8	1	GG	97,5	23	26	26	78	1210
TB 8 PJ 102,5	8	1	GG	102,5	23	26	26	85	1610
TB 8 PJ 107,5	8	1	GG	107,5	23	26	26	85	1610
TB 8 PJ 112,5	8	1	GG	112,5	23	26	26	85	1610
TB 8 PJ 117,5	8	1	GG	117,5	23	26	26	85	1610
TB 8 PJ 122,5	8	1	GG	122,5	23	26	26	85	1610
TB 8 PJ 127,5	8	1	GG	127,5	23	26	26	85	1610
TB 8 PJ 137,5	8	1	GG	137,5	23	26	26	85	1610

Bezeichnung	Anzahl der Rillen	Ausführung	Material	d _e (mm)	b ₂ (mm)	B (mm)	N (mm)	D (mm)	Taperbuchse
TB 8 PJ 152,5	8	1	GG	152,5	23	26	26	85	1610
TB 8 PJ 162,5	8	1	GG	162,5	23	26	26	85	1610
TB 8 PJ 172,5	8	1	GG	172,5	23	26	26	85	1610
TB 8 PJ 182,5	8	1	GG	182,5	23	26	26	85	1610
TB 8 PJ 192,5	8	1	GG	192,5	23	26	26	85	1610
TB 8 PJ 202,5	8	1	GG	202,5	23	33	33	100	2012
TB 8 PJ 222,5	8	1	GG	222,5	23	33	33	100	2012
12PJ									
TB 12 PJ 62,5	12	2	GG	62,5	32	32	23	50	1108
TB 12 PJ 67,5	12	2	GG	67,5	32	32	23	50	1108
TB 12 PJ 72,5	12	2	GG	72,5	32	32	26	50	1108
TB 12 PJ 77,5	12	2	GG	77,5	32	32	26	62	1210
TB 12 PJ 82,5	12	2	GG	82,5	32	32	26	62	1210
TB 12 PJ 87,5	12	2	GG	87,5	32	32	26	70	1610
TB 12 PJ 92,5	12	2	GG	92,5	32	32	26	70	1610
TB 12 PJ 97,5	12	2	GG	97,5	32	32	26	70	1610
TB 12 PJ 102,5	12	2	GG	102,5	32	32	26	70	1610
TB 12 PJ 107,5	12	2	GG	107,5	32	32	26	70	1610
TB 12 PJ 112,5	12	2	GG	112,5	32	32	33	70	1610
TB 12 PJ 117,5	12	2	GG	117,5	32	32	33	70	1610
TB 12 PJ 122,5	12	2	GG	122,5	32	32	33	70	1610
TB 12 PJ 127,5	12	1	GG	127,5	32	32	33	100	2012
TB 12 PJ 137,5	12	1	GG	137,5	32	32	33	100	2012
TB 12 PJ 152,5	12	1	GG	152,5	32	32	33	100	2012
TB 12 PJ 162,5	12	1	GG	162,5	32	32	33	100	2012
TB 12 PJ 172,5	12	1	GG	172,5	32	32	33	100	2012
TB 12 PJ 182,5	12	1	GG	182,5	32	46	46	110	2517
TB 12 PJ 192,5	12	1	GG	192,5	32	46	46	110	2517
TB 12 PJ 202,5	12	1	GG	202,5	32	46	46	110	2517
TB 12 PJ 222,5	12	1	GG	222,5	32	46	46	110	2517
16PJ									
TB 16 PJ 62,5	16	2	GG	62,5	41	41	23	50	1108
TB 16 PJ 67,5	16	2	GG	67,5	41	41	23	50	1108
TB 16 PJ 72,5	16	2	GG	72,5	41	41	26	62	1210
TB 16 PJ 77,5	16	2	GG	77,5	41	41	26	62	1210
TB 16 PJ 82,5	16	2	GG	82,5	41	41	26	62	1210
TB 16 PJ 87,5	16	2	GG	87,5	41	41	26	70	1610
TB 16 PJ 92,5	16	2	GG	92,5	41	41	26	70	1610
TB 16 PJ 97,5	16	2	GG	97,5	41	41	26	70	1610
TB 16 PJ 102,5	16	2	GG	102,5	41	41	26	70	1610
TB 16 PJ 107,5	16	2	GG	107,5	41	41	26	70	1610
TB 16 PJ 112,5	16	2	GG	112,5	41	41	33	85	2012
TB 16 PJ 117,5	16	2	GG	117,5	41	41	33	85	2012
TB 16 PJ 122,5	16	2	GG	122,5	41	41	33	85	2012
TB 16 PJ 127,5	16	2	GG	127,5	41	41	33	85	2012
TB 16 PJ 137,5	16	2	GG	137,5	41	41	33	85	2012
TB 16 PJ 152,5	16	2	GG	152,5	41	41	33	85	2012
TB 16 PJ 162,5	16	2	GG	162,5	41	41	33	85	2012
TB 16 PJ 172,5	16	2	GG	172,5	41	41	33	85	2012
TB 16 PJ 182,5	16	1	GG	182,5	41	46	46	110	2517
TB 16 PJ 192,5	16	1	GG	192,5	41	46	46	110	2517
TB 16 PJ 202,5	16	1	GG	202,5	41	46	46	110	2517

Bezeichnung	Anzahl der Rillen	Ausführung	Material	d _b (mm)	b ₂ (mm)	B (mm)	N (mm)	D (mm)	Taperbuchse
TB 16 PJ 222,5	16	1	GG	222,5	41	46	46	110	2517
6PL									
TB 6 PL 78	6	2	GG	78,0	33	33	26	62	1210
TB 6 PL 83	6	2	GG	83,0	33	33	26	62	1210
TB 6 PL 88	6	2	GG	88,0	33	33	26	70	1610
TB 6 PL 93	6	2	GG	93,0	33	33	26	70	1610
TB 6 PL 98	6	2	GG	98,0	33	33	26	70	1610
TB 6 PL 103	6	2	GG	103,0	33	33	26	70	1610
TB 6 PL 108	6	2	GG	108,0	33	33	26	70	1610
TB 6 PL 113	6	2	GG	113,0	33	33	26	70	1610
TB 6 PL 118	6	2	GG	118,0	33	33	26	70	1610
TB 6 PL 123	6	4	GG	123,0	33	33	33	-	2012
TB 6 PL 133	6	4	GG	133,0	33	33	33	-	2012
TB 6 PL 148	6	4	GG	148,0	33	33	33	-	2012
TB 6 PL 158	6	4	GG	158,0	33	33	33	-	2012
TB 6 PL 168	6	4	GG	168,0	33	33	33	-	2012
TB 6 PL 178	6	1	GG	178,0	33	46	46	110	2517
TB 6 PL 188	6	1	GG	188,0	33	46	46	110	2517
TB 6 PL 198	6	1	GG	198,0	33	46	46	110	2517
TB 6 PL 218	6	1	GG	218,0	33	46	46	110	2517
TB 6 PL 238	6	1	GG	238,0	33	46	46	110	2517
TB 6 PL 258	6	1	GG	258,0	33	46	46	110	2517
TB 6 PL 278	6	1	GG	278,0	33	46	46	110	2517
TB 6 PL 298	6	1	GG	298,0	33	46	46	110	2517
TB 6 PL 318	6	1	GG	318,0	33	46	46	110	2517
TB 6 PL 348	6	1	GG	348,0	33	46	46	110	2517
TB 6 PL 388	6	1	GG	388,0	33	46	46	110	2517
8PL									
TB 8 PL 78	8	2	GG	78,0	42	42	26	62	1210
TB 8 PL 83	8	2	GG	83,0	42	42	26	62	1210
TB 8 PL 88	8	2	GG	88,0	42	42	26	70	1610
TB 8 PL 93	8	2	GG	93,0	42	42	26	70	1610
TB 8 PL 98	8	2	GG	98,0	42	42	26	70	1610
TB 8 PL 103	8	2	GG	103,0	42	42	33	85	2012
TB 8 PL 108	8	2	GG	108,0	42	42	33	85	2012
TB 8 PL 113	8	2	GG	113,0	42	42	33	85	2012
TB 8 PL 118	8	2	GG	118,0	42	42	33	85	2012
TB 8 PL 123	8	2	GG	123,0	42	42	33	85	2012
TB 8 PL 133	8	2	GG	133,0	42	42	33	85	2012
TB 8 PL 148	8	2	GG	148,0	42	42	33	85	2012
TB 8 PL 158	8	2	GG	158,0	42	42	33	85	2012
TB 8 PL 168	8	2	GG	168,0	42	42	33	85	2012
TB 8 PL 178	8	1	GG	178,0	42	46	46	110	2517
TB 8 PL 188	8	1	GG	188,0	42	46	46	110	2517
TB 8 PL 198	8	1	GG	198,0	42	46	46	110	2517
TB 8 PL 218	8	1	GG	218,0	42	46	46	110	2517
TB 8 PL 238	8	1	GG	238,0	42	46	46	110	2517
TB 8 PL 258	8	1	GG	258,0	42	46	46	110	2517
TB 8 PL 278	8	1	GG	278,0	42	46	46	110	2517
TB 8 PL 298	8	1	GG	298,0	42	46	46	110	2517
TB 8 PL 318	8	1	GG	318,0	42	46	46	110	2517
TB 8 PL 348	8	1	GG	348,0	42	46	46	110	2517

Bezeichnung	Anzahl der Rillen	Ausführung	Material	d _e (mm)	b ₂ (mm)	B (mm)	N (mm)	D (mm)	Taperbuchse	
TB 8 PL 388	8	1	GG	388,0	42	46	46	110	2517	
10PL										
TB 10 PL 88	10	3	GG	88,0	53	53	26	70	1610	
TB 10 PL 93	10	3	GG	93,0	53	53	26	70	1610	
TB 10 PL 98	10	3	GG	98,0	53	53	26	70	1610	
TB 10 PL 103	10	2	GG	103,0	53	53	33	85	2012	
TB 10 PL 108	10	2	GG	108,0	53	53	33	85	2012	
TB 10 PL 113	10	2	GG	113,0	53	53	33	85	2012	
TB 10 PL 118	10	2	GG	118,0	53	53	33	85	2012	
TB 10 PL 123	10	2	GG	123,0	53	53	33	85	2012	
TB 10 PL 133	10	2	GG	133,0	53	53	33	85	2012	
TB 10 PL 148	10	2	GG	148,0	53	53	33	85	2012	
TB 10 PL 158	10	2	GG	158,0	53	53	33	85	2012	
TB 10 PL 168	10	2	GG	168,0	53	53	33	85	2012	
TB 10 PL 178	10	2	GG	178,0	53	53	46	105	2517	
TB 10 PL 188	10	2	GG	188,0	53	53	46	105	2517	
TB 10 PL 198	10	2	GG	198,0	53	53	46	105	2517	
TB 10 PL 218	10	2	GG	218,0	53	53	46	105	2517	
TB 10 PL 238	10	2	GG	238,0	53	53	46	105	2517	
TB 10 PL 258	10	2	GG	258,0	53	53	46	105	2517	
TB 10 PL 278	10	2	GG	278,0	53	53	46	105	2517	
TB 10 PL 298	10	2	GG	298,0	53	53	46	105	2517	
TB 10 PL 318	10	2	GG	318,0	53	53	46	105	2517	
TB 10 PL 348	10	2	GG	348,0	53	53	46	105	2517	
TB 10 PL 388	10	2	GG	388,0	53	53	46	105	2517	
12PL										
TB 12 PL 88	12	3	GG	88,0	62	62	26	70	1610	
TB 12 PL 93	12	3	GG	93,0	62	62	26	70	1610	
TB 12 PL 98	12	3	GG	98,0	62	62	26	70	1610	
TB 12 PL 103	12	3	GG	103,0	62	62	33	85	2012	
TB 12 PL 108	12	3	GG	108,0	62	62	33	85	2012	
TB 12 PL 113	12	3	GG	113,0	62	62	33	85	2012	
TB 12 PL 118	12	3	GG	118,0	62	62	33	85	2012	
TB 12 PL 123	12	3	GG	123,0	62	62	33	85	2012	
TB 12 PL 133	12	3	GG	133,0	62	62	33	85	2012	
TB 12 PL 148	12	2	GG	148,0	62	62	46	105	2517	
TB 12 PL 158	12	2	GG	158,0	62	62	46	105	2517	
TB 12 PL 168	12	2	GG	168,0	62	62	46	105	2517	
TB 12 PL 178	12	2	GG	178,0	62	62	46	105	2517	
TB 12 PL 188	12	2	GG	188,0	62	62	46	105	2517	
TB 12 PL 198	12	2	GG	198,0	62	62	46	105	2517	
TB 12 PL 218	12	2	GG	218,0	62	62	46	105	2517	
TB 12 PL 238	12	2	GG	238,0	62	62	52	130	3020	
TB 12 PL 258	12	2	GG	258,0	62	62	52	130	3020	
TB 12 PL 278	12	2	GG	278,0	62	62	52	130	3020	
TB 12 PL 298	12	2	GG	298,0	62	62	52	130	3020	
TB 12 PL 318	12	2	GG	318,0	62	62	52	130	3020	
TB 12 PL 348	12	2	GG	348,0	62	62	52	130	3020	
TB 12 PL 388	12	2	GG	388,0	62	62	52	130	3020	
16PL										
TB 16 PL 103	16	3	GG	103,0	80	80	33	85	2012	
TB 16 PL 108	16	3	GG	108,0	80	80	33	85	2012	

Bezeichnung	Anzahl der Rillen	Ausführung	Material	d _b (mm)	b ₂ (mm)	B (mm)	N (mm)	D (mm)	Taperbuchse
TB 16 PL 113	16	3	GG	113,0	80	80	33	85	2012
TB 16 PL 118	16	3	GG	118,0	80	80	33	85	2012
TB 16 PL 123	16	3	GG	123,0	80	80	33	85	2012
TB 16 PL 133	16	3	GG	133,0	80	80	33	85	2012
TB 16 PL 148	16	3	GG	148,0	80	80	46	105	2517
TB 16 PL 158	16	3	GG	158,0	80	80	46	105	2517
TB 16 PL 168	16	3	GG	168,0	80	80	46	105	2517
TB 16 PL 178	16	3	GG	178,0	80	80	46	105	2517
TB 16 PL 188	16	3	GG	188,0	80	80	46	105	2517
TB 16 PL 198	16	3	GG	198,0	80	80	46	105	2517
TB 16 PL 218	16	3	GG	218,0	80	80	46	105	2517
TB 16 PL 238	16	3	GG	238,0	80	80	52	130	3020
TB 16 PL 258	16	3	GG	258,0	80	80	52	130	3020
TB 16 PL 278	16	3	GG	278,0	80	80	52	130	3020
TB 16 PL 298	16	3	GG	298,0	80	80	52	130	3020
TB 16 PL 318	16	3	GG	318,0	80	80	52	130	3020
TB 16 PL 348	16	3	GG	348,0	80	80	52	130	3020
TB 16 PL 388	16	3	GG	388,0	80	80	52	130	3020

Taper-Buchse	1008	1108	1210	1610	2012	2517	3020	3535
Bohrung d ₂ (mm) von... bis...	10-25	10-28	11-32	14-42	14-50	16-65	25-75	35-90

GG = Grauguss Weitere Abmessungen auf Anfrage. Fertigungstechnische Änderungen vorbehalten.
Bohrungsdurchmesser d₂ siehe Seite 4.

**optibelt RBS Keilrippenscheiben für zylindrische Bohrung
Sondergrößen im Profil PJ**

Bezeichnung	Anzahl der Rillen	Ausführung	Material	d _b (mm)	b ₁ (mm)	B (mm)	D (mm)	Vorbohrung d (mm)	Fertigbohrung d _{max} (mm)	Gewicht (=kg)
4PJ										
4 PJ 22,5	4	VB	GG	22,5	13	20	25	8	12	0,045
4 PJ 27,5	4	VB	GG	27,5	13	20	30	8	14	0,070
4 PJ 32,5	4	VB	GG	32,5	13	20	35	8	18	0,100
4 PJ 37,5	4	VB	GG	37,5	13	20	40	8	20	0,135
4 PJ 42,5	4	VB	GG	42,5	13	20	45	8	22	0,180
8PJ										
8 PJ 22,5	8	VB	GG	22,5	23	30	25	8	12	0,063
8 PJ 27,5	8	VB	GG	27,5	23	30	30	8	14	0,100
8 PJ 32,5	8	VB	GG	32,5	23	30	35	8	18	0,150
8 PJ 37,5	8	VB	GG	37,5	23	30	40	8	20	0,200
8 PJ 42,5	8	VB	GG	42,5	23	30	45	8	22	0,265
12PJ										
12 PJ 22,5	12	VB	GG	22,5	32	40	25	8	12	0,086
12 PJ 27,5	12	VB	GG	27,5	32	40	30	8	14	0,140
12 PJ 32,5	12	VB	GG	32,5	32	40	35	8	18	0,200
12 PJ 37,5	12	VB	GG	37,5	32	40	40	8	20	0,280
12 PJ 42,5	12	VB	GG	42,5	32	40	45	8	22	0,360

GG = Grauguss Weitere Abmessungen auf Anfrage. Fertigungstechnische Änderungen vorbehalten.

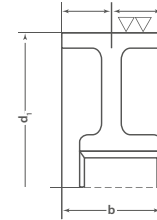
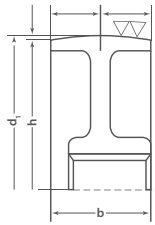

Bezeichnung	Taperbuchse
FS	
TB 63 x 50*	1108
TB 80 x 50*	1210
TB 80 x 80*	1615
TB 90 x 50*	1615
TB 90 x 80*	1615
TB 90 x 100*	1615
TB 100 x 50*	1615
TB 100 x 80*	1615
TB 100 x 100*	1615
TB 125 x 50*	2012
TB 125 x 80*	2517
TB 125 x 100*	2517
TB 125 x 125*	2517
TB 140 x 50*	2012
TB 140 x 80*	2517
TB 140 x 100*	3020
TB 140 x 125*	3030
TB 150 x 50*	2012
TB 150 x 80*	2517
TB 150 x 100*	3020
TB 150 x 125*	3030
TB 150 x 160*	3030
TB 160 x 50*	2012
TB 160 x 80*	2517
TB 160 x 100*	3020
TB 160 x 125*	3030
TB 160 x 160*	3030
TB 180 x 80*	2517
TB 180 x 100*	3020
TB 180 x 125*	3030
TB 180 x 160*	3030
TB 200 x 80*	2517
TB 200 x 100*	3020
TB 200 x 125*	3030
TB 200 x 160*	3030
TB 224 x 50*	2517
TB 224 x 80*	2517
TB 224 x 100*	3020
TB 224 x 125*	3030
TB 224 x 160*	3030
TB 250 x 80*	2517
TB 250 x 100*	3020
TB 250 x 125*	3030

Bezeichnung	Taperbuchse
TB 250 x 160*	3030
TB 280 x 100*	3020
TB 280 x 125*	3030
TB 280 x 160*	3535
TB 280 x 200*	4040
TB 315 x 100*	3020
TB 315 x 125*	3030
TB 315 x 160*	3535
TB 315 x 200*	4040
TB 355 x 100*	3030
TB 355 x 125*	3030
TB 355 x 160*	3535
TB 355 x 200*	4040
TB 400 x 100*	3535
TB 400 x 125*	3535
TB 400 x 160*	3535
TB 400 x 200*	4040
TB 450 x 160*	3535
TB 450 x 200*	4040
TB 500 x 160*	4040
TB 500 x 200*	4545
TB 560 x 160*	4040
TB 560 x 200*	4545
TB 630 x 160*	4545

Taper-Buchse	1108	1210	1615	2012	2517	3020	3030	3535	4040	4545
Bohrung d ₂ (mm) von... bis...	10-28	11-32	14-42	14-50	16-65	25-75	35-75	35-90	40-100	55-110

Bohrungsdurchmesser d₂, siehe Seite 4. Material: EN-GJL 200
 Fertigungstechnische Änderungen vorbehalten.
 * Keine Lagerware



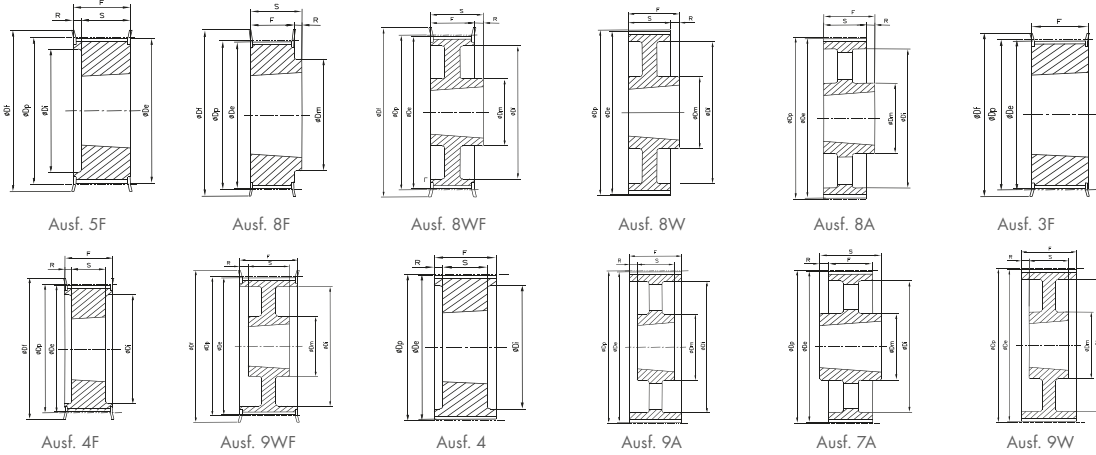

Bezeichnung	Anzahl der Zähne	Ausführung	Material	D _p (mm)	D _e (mm)	D _f (mm)	F (mm)	S (mm)	R (mm)	D _m (mm)	D _i (mm)	Taperbuchse	Gewicht ohne Buchse (≈kg)
8M - Teilung 8 mm für Riemenbreite 20 mm													
TB 22 8M 20	22	5F	ST	56,02	54,65	60	28	22	6	-	37	1008	0,240
TB 24 8M 20	24	5F	ST	61,12	59,75	66	28	22	6	-	44	1108	0,300
TB 26 8M 20	26	5F	ST	66,21	64,84	70	28	22	6	-	45	1108	0,360
TB 28 8M 20	28	5F	ST	71,30	70,08	75	28	22	6	-	50	1108	0,440
TB 30 8M 20	30	5F	ST	76,39	75,13	83	28	22	6	-	58	1108	0,530
TB 32 8M 20	32	5F	ST	81,49	80,16	87	28	25	3	-	63	1610	0,420
TB 34 8M 20	34	5F	ST	86,58	85,22	91	28	25	3	-	64	1610	0,550
TB 36 8M 20	36	5F	ST	91,67	90,30	97	28	25	3	-	68	1610	0,680
TB 38 8M 20	38	5F	ST	96,77	95,39	102	28	25	3	-	72	1610	0,800
TB 40 8M 20	40	5F	ST	101,86	100,49	106	28	25	3	-	76	1610	1,000
TB 44 8M 20	44	8F	ST	112,05	110,67	120	28	32	4	93	-	2012	1,200
TB 48 8M 20	48	8F	ST	122,23	120,86	128	28	32	4	96	-	2012	1,600
TB 56 8M 20	56	8F	ST	142,60	141,23	150	28	32	4	110	-	2012	2,400
TB 64 8M 20	64	8WF	ST	162,97	161,60	168	28	32	4	110	137	2012	2,700
TB 72 8M 20	72	8WF	ST	183,35	181,97	192	28	32	4	110	158	2012	3,300
TB 80 8M 20	80	8W	GG	203,72	202,35	-	28	32	4	110	180	2012	3,500
TB 90 8M 20	90	8A	GG	229,18	227,81	-	28	32	4	110	204	2012	3,650
8M - Teilung 8 mm für Riemenbreite 30 mm													
TB 22 8M 30	22	5F	ST	56,02	54,65	60	38	22	16	-	37	1008	0,290
TB 24 8M 30	24	5F	ST	61,12	59,75	66	38	22	16	-	44	1108	0,380
TB 26 8M 30	26	5F	ST	66,21	64,84	70	38	22	16	-	44	1108	0,450
TB 28 8M 30	28	5F	ST	71,30	70,08	75	38	25	13	-	50	1210	0,500
TB 30 8M 30	30	3F	ST	76,39	75,13	83	38	38	-	-	-	1615	0,450
TB 32 8M 30	32	3F	ST	81,49	80,16	87	38	38	-	-	-	1615	0,590
TB 34 8M 30	34	3F	ST	86,58	85,22	91	38	38	-	-	-	1615	0,770
TB 36 8M 30	36	3F	ST	91,67	90,30	97	38	38	-	-	-	1615	0,960
TB 38 8M 30	38	3F	ST	96,77	95,39	102	38	38	-	-	-	1615	1,150
TB 40 8M 30	40	3F	ST	101,86	100,49	106	38	38	-	-	-	1615	1,340
TB 44 8M 30	44	4F	ST	112,05	110,67	120	38	32	3	-	86	2012	1,330
TB 48 8M 30	48	4F	ST	122,23	120,86	128	38	32	3	-	90	2012	1,780
TB 56 8M 30	56	4F	ST	142,60	141,23	150	38	32	3	-	110	2012	3,760
TB 64 8M 30	64	8F	ST	162,97	161,60	168	38	45	7	125	-	2517	4,200
TB 72 8M 30	72	8WF	ST	183,35	181,97	192	38	45	7	125	158	2517	4,300
TB 80 8M 30	80	8W	GG	203,72	202,35	-	38	45	7	125	180	2517	4,600
TB 90 8M 30	90	8A	GG	229,18	227,81	-	38	45	7	125	204	2517	5,000
TB 112 8M 30	112	8A	GG	285,21	283,83	-	38	45	7	125	254	2517	6,200
TB 144 8M 30	144	8A	GG	366,69	365,32	-	38	45	7	125	336	2517	9,000

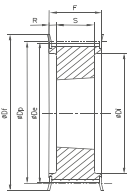

Ausf. 4F

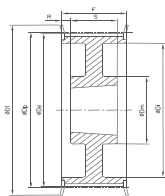

Ausf. 9WF

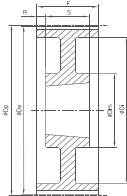

Ausf. 9W

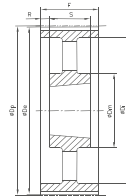

Ausf. 9A

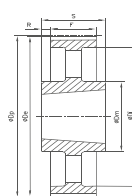

Ausf. 7A

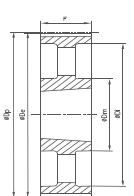

Ausf. 3A

Bezeichnung	Anzahl der Zähne	Ausführung	Material	D _p (mm)	D _e (mm)	D _f (mm)	F (mm)	S (mm)	R (mm)	D _m (mm)	D _i (mm)	Taperbuchse	Gewicht ohne Buchse (≈kg)
14M - Teilung 14 mm für Riemenbreite 40 mm													
TB 28 14M 40	28	4F	ST	124,78	122,12	128	54	32	11	-	94	2012	2,000
TB 29 14M 40	29	4F	ST	129,23	126,57	138	54	32	11	-	98	2012	2,380
TB 30 14M 40	30	4F	ST	133,69	130,99	138	54	32	11	-	98	2012	2,650
TB 32 14M 40	32	4F	ST	142,60	139,88	154	54	32	11	-	108	2012	3,400
TB 34 14M 40	34	4F	ST	151,52	148,79	160	54	45	4,5	-	110	2517	3,870
TB 36 14M 40	36	4F	ST	160,43	157,68	168	54	45	4,5	-	120	2517	4,800
TB 38 14M 40	38	4F	ST	169,34	166,60	183	54	45	4,5	-	130	2517	5,400
TB 40 14M 40	40	4F	ST	178,25	175,49	188	54	45	4,5	-	138	2517	6,000
TB 44 14M 40	44	4F	ST	196,08	193,28	211	54	51	1,5	-	155	3020	7,800
TB 48 14M 40	48	4F	ST	213,90	211,11	226	54	51	1,5	-	170	3020	9,400
TB 56 14M 40	56	9WF	ST	249,55	246,76	256	54	51	1,5	170	208	3020	10,800
TB 64 14M 40	64	9WF	GG	285,21	282,41	296	54	51	1,5	170	240	3020	13,400
TB 72 14M 40	72	9W	GG	320,86	318,06	-	54	51	1,5	170	280	3020	15,200
TB 80 14M 40	80	9A	GG	356,51	353,71	-	54	51	1,5	170	315	3020	16,000
TB 90 14M 40	90	9A	GG	401,07	398,28	-	54	51	1,5	170	360	3020	17,800
TB 112 14M 40	112	9A	GG	499,11	496,32	-	54	51	1,5	170	457	3020	25,600
TB 144 14M 40	144	9A	GG	641,71	638,92	-	54	51	1,5	170	600	3020	32,000
TB 168 14M 40	168	9A	GG	748,66	745,87	-	54	51	1,5	170	706	3020	44,000
TB 192 14M 40	192	9A	GG	855,62	852,82	-	54	51	1,5	170	813	3020	49,000
TB 216 14M 40	216	9A	GG	962,57	959,77	-	54	51	1,5	170	920	3020	55,000
14M - Teilung 14 mm für Riemenbreite 55 mm													
TB 28 14M 55	28	4F	ST	124,78	122,12	128	70	32	19	-	98	2012	2,200
TB 29 14M 55	29	4F	ST	129,23	126,57	138	70	32	19	-	100	2517	2,740
TB 30 14M 55	30	4F	ST	133,69	130,99	138	70	45	12,5	-	100	2517	2,700
TB 32 14M 55	32	4F	ST	142,60	139,88	154	70	45	12,5	-	108	2517	3,660
TB 34 14M 55	34	4F	ST	151,52	148,79	160	70	45	12,5	-	110	2517	4,550
TB 36 14M 55	36	4F	ST	160,43	157,68	168	70	45	12,5	-	120	2517	5,200
TB 38 14M 55	38	4F	ST	169,34	166,60	183	70	45	12,5	-	130	2517	6,200
TB 40 14M 55	40	4F	ST	178,25	175,49	188	70	45	12,5	-	138	2517	7,000
TB 44 14M 55	44	4F	ST	196,08	193,28	211	70	51	9,5	-	155	3020	8,600
TB 48 14M 55	48	4F	ST	213,90	211,11	226	70	51	9,5	-	170	3020	10,400
TB 56 14M 55	56	9WF	ST	249,55	246,76	256	70	51	9,5	170	208	3020	12,000
TB 64 14M 55	64	9WF	GG	285,21	282,41	296	70	51	9,5	170	242	3020	14,500
TB 72 14M 55	72	9W	GG	320,86	318,06	-	70	51	9,5	170	280	3020	16,200
TB 80 14M 55	80	9A	GG	356,51	353,71	-	70	51	9,5	170	315	3020	17,500
TB 90 14M 55	90	9A	GG	401,07	398,28	-	70	51	9,5	170	360	3020	20,100
TB 112 14M 55	112	9A	GG	499,11	496,32	-	70	51	9,5	170	457	3020	28,400
TB 144 14M 55	144	9A	GG	641,71	638,92	-	70	51	9,5	170	600	3020	36,200
TB 168 14M 55	168	9A	GG	748,66	745,87	-	70	51	9,5	170	706	3020	49,000
TB 192 14M 55	192	9A	GG	855,62	852,82	-	70	51	9,5	170	813	3020	53,000
TB 216 14M 55	216	7A	GG	962,57	959,76	-	70	89	9,5	190	920	3535	65,800
14M - Teilung 14 mm für Riemenbreite 85 mm													
TB 28 14M 85	28	4F	ST	124,78	122,12	128	102	45	28,5	-	98	2517	2,700

Bezeichnung	Anzahl der Zähne	Ausführung	Material	D _p (mm)	D _e (me)	D _f (mm)	F (mm)	S (mm)	R (mm)	D _m (mm)	D _i (mm)	Taperbuchse	Gewicht ohne Buchse (=kg)
TB 29 14M 85	29	4F	ST	129,23	126,57	138	102	45	28,5	-	100	2517	3,400
TB 30 14M 85	30	4F	ST	133,69	130,99	138	102	45	28,5	-	100	2517	3,750
TB 32 14M 85	32	4F	ST	142,60	139,88	154	102	45	28,5	-	108	2517	4,800
TB 34 14M 85	34	4F	ST	151,52	148,79	160	102	45	28,5	-	110	2517	6,000
TB 36 14M 85	36	4F	ST	160,43	157,68	168	102	51	25,5	-	120	3020	5,800
TB 38 14M 85	38	4F	ST	169,34	166,60	183	102	51	25,5	-	130	3020	6,800
TB 40 14M 85	40	4F	ST	178,25	175,49	188	102	51	25,5	-	138	3020	8,000
TB 44 14M 85	44	4F	ST	196,08	193,28	211	102	51	25,5	-	155	3030	11,800
TB 48 14M 85	48	4F	ST	213,90	211,11	226	102	51	25,5	-	170	3030	15,100
TB 56 14M 85	56	4F	ST	249,55	246,76	256	102	65	18,5	-	210	3525	19,000
TB 64 14M 85	64	9WF	GG	285,21	282,41	296	102	65	18,5	190	242	3525	23,000
TB 72 14M 85	72	9W	GG	320,86	318,06	-	102	65	18,5	190	280	3525	25,000
TB 80 14M 85	80	9A	GG	356,51	353,71	-	102	65	18,5	190	315	3525	26,000
TB 90 14M 85	90	9A	GG	401,07	398,28	-	102	65	18,5	190	360	3525	27,800
TB 112 14M 85	112	9A	GG	499,11	496,32	-	102	65	18,5	190	457	3525	36,500
TB 144 14M 85	144	9A	GG	641,71	638,92	-	102	65	18,5	190	600	3525	48,000
TB 168 14M 85	168	9A	GG	748,66	745,87	-	102	65	18,5	190	706	3525	60,000
TB 192 14M 85	192	3A	GG	855,62	852,82	-	102	102	-	190	813	4040	86,000
TB 216 14M 85	216	3A	GG	962,57	959,77	-	102	102	-	190	920	4040	91,500
14M - Teilung 14 mm für Riemenbreite 115 mm													
TB 28 14M 115	28	4F	ST	124,78	122,12	128	133	45	44	-	98	2517	3,770
TB 29 14M 115	29	4F	ST	129,23	126,57	138	133	45	44	-	100	2517	4,000
TB 30 14M 115	30	4F	ST	133,69	130,99	138	133	45	44	-	100	2517	5,000
TB 32 14M 115	32	4F	ST	142,60	139,88	154	133	45	44	-	108	2517	6,800
TB 34 14M 115	34	4F	ST	151,52	148,79	160	133	45	44	-	110	2517	6,800
TB 36 14M 115	36	4F	ST	160,43	157,68	168	133	51	41	-	120	3020	7,000
TB 38 14M 115	38	4F	ST	169,34	166,60	183	133	51	41	-	130	3020	8,400
TB 40 14M 115	40	4F	ST	178,25	175,49	188	133	51	41	-	138	3020	9,200
TB 44 14M 115	44	4F	ST	196,08	193,28	211	133	76	28,5	-	155	3030	14,000
TB 48 14M 115	48	4F	ST	213,90	211,11	226	133	76	28,5	-	170	3030	17,100
TB 56 14M 115	56	4F	ST	249,55	246,76	256	133	89	22	-	208	3535	24,800
TB 64 14M 115	64	9WF	GG	285,21	282,41	296	133	89	22	190	240	3535	27,000
TB 72 14M 115	72	9W	GG	320,86	318,06	-	133	89	22	190	280	3535	29,000
TB 80 14M 115	80	9A	GG	356,51	353,71	-	133	89	22	190	315	3535	32,000
TB 90 14M 115	90	9A	GG	401,07	398,28	-	133	89	22	190	360	3535	36,500
TB 112 14M 115	112	9A	GG	499,11	496,32	-	133	89	22	190	457	3535	46,000
TB 144 14M 115	144	9A	GG	641,71	638,92	-	133	102	15,5	230	600	4040	68,000
TB 168 14M 115	168	9A	GG	748,66	745,87	-	133	102	15,5	230	706	4040	82,600
TB 192 14M 115	192	9A	GG	855,62	852,82	-	133	102	15,5	230	813	4040	96,000
TB 216 14M 115	216	9A	GG	962,57	959,76	-	133	102	15,5	230	920	4040	107,000
14M - Teilung 14 mm für Riemenbreite 170 mm													
TB 38 14M 170*	38	4F	ST	169,34	166,60	183	187	76	55,5	-	130	3030	11,700
TB 40 14M 170*	40	4F	ST	178,25	175,49	188	187	76	55,5	-	138	3030	13,000
TB 44 14M 170*	44	4F	ST	196,08	193,28	211	187	89	49	-	153	3535	15,000
TB 48 14M 170*	48	4F	ST	213,90	211,11	226	187	89	49	-	170	3535	19,000
TB 56 14M 170*	56	4F	ST	249,55	246,76	256	187	89	49	-	208	3535	28,500
TB 64 14M 170*	64	4F	GG	285,21	282,41	296	187	102	42,5	-	240	4040	41,000
TB 72 14M 170*	72	9W	GG	320,86	318,06	-	187	102	42,5	230	280	4040	46,900
TB 80 14M 170*	80	9W	GG	356,51	353,71	-	187	102	42,5	230	315	4040	48,000
TB 90 14M 170*	90	9A	GG	401,07	398,28	-	187	102	42,5	230	360	4040	52,500



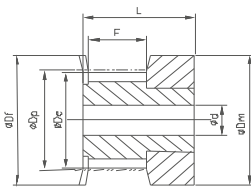

Ausf. 1F

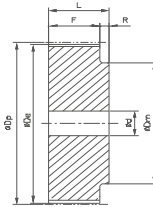

Ausf. 6

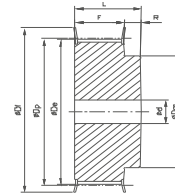

Ausf. 6F

Bezeichnung	Anzahl der Zähne	Ausführung	Material	D _p (mm)	D _e (mm)	D _i (mm)	F (mm)	L (mm)	D _m (mm)	Vorbohrung d (mm)	Fertigbohrung d _{max} (mm)	Gewicht (kg)
3M - Teilung 3 mm für Riemenbreite 6 mm												
10 3M 6*	10	1F	AL	9,55	8,79	13	7,2	14,5	13	-	3	-
12 3M 6*	12	1F	AL	11,46	10,70	15	7,2	14,5	15	-	5	-
14 3M 6*	14	1F	AL	13,37	12,61	16	7,2	14,5	16	-	6	-
15 3M 6*	15	1F	AL	14,32	13,56	17,5	7,2	14,5	17,5	-	6	-
16 3M 6*	16	6F	AL	15,28	14,52	17,5	9,8	17,5	10	-	7	-
18 3M 6*	18	6F	AL	17,19	16,43	20	9,8	17,5	11	-	8	-
20 3M 6*	20	6F	AL	19,10	18,34	23	9,8	17,5	13	-	9	-
21 3M 6*	21	6F	AL	20,05	19,29	25	9,8	17,5	13	-	9	-
22 3M 6*	22	6F	AL	21,01	20,25	25	9,8	17,5	13	-	9	-
24 3M 6*	24	6F	AL	22,92	22,16	25	9,8	17,5	13	-	9	-
26 3M 6*	26	6F	AL	24,83	24,07	28	9,8	17,5	16	-	11	-
28 3M 6*	28	6F	AL	26,74	25,98	32	9,8	17,5	18	-	12	-
30 3M 6*	30	6F	AL	28,65	27,89	32	9,8	17,5	20	-	14	-
32 3M 6*	32	6F	AL	30,56	29,80	36	9,8	17,5	22	-	15	-
36 3M 6*	36	6F	AL	34,38	33,62	39	10,3	18	26	-	16	-
40 3M 6*	40	6F	AL	38,20	37,44	42	10,3	18	28	-	18	-
44 3M 6*	44	6F	AL	42,02	41,26	48	10,3	18	33	-	20	-
48 3M 6*	48	6	AL	45,84	45,08	-	10,3	18,6	33	8	20	-
60 3M 6*	60	6	AL	57,30	56,54	-	10,3	18,6	33	8	20	-
72 3M 6*	72	6	AL	68,75	67,99	-	10,3	18,6	33	8	20	-
3M - Teilung 3 mm für Riemenbreite 9 mm												
10 3M 9	10	1F	AL	9,55	8,79	13	10,2	17,5	13	-	3	0,004
12 3M 9	12	1F	AL	11,46	10,70	15	10,2	17,5	15	-	5	0,006
14 3M 9	14	1F	AL	13,37	12,61	16	10,2	17,5	16	-	6	0,007
15 3M 9	15	1F	AL	14,32	13,56	17,5	10,2	17,5	17,5	-	6	0,008
16 3M 9	16	1F	AL	15,28	14,52	17,5	12,8	20,6	10	-	7	0,007
18 3M 9	18	6F	AL	17,19	16,43	20	12,8	20,6	10,6	-	8	0,008
20 3M 9	20	6F	AL	19,10	18,34	23	12,8	20,6	12,4	-	9	0,010
21 3M 9	21	6F	AL	20,05	19,29	25	12,8	20,6	13	-	9	0,013
22 3M 9	22	6F	AL	21,01	20,25	25	12,8	20,6	13	-	9	0,014
24 3M 9	24	6F	AL	22,92	22,16	25	12,8	20,6	13	-	9	0,016
26 3M 9	26	6F	AL	24,83	24,07	28	12,8	20,6	16	-	11	0,018
28 3M 9	28	6F	AL	26,74	25,98	32	12,8	20,6	18	-	12	0,024
30 3M 9	30	6F	AL	28,65	27,89	32	12,8	20,6	20	-	14	0,028
32 3M 9	32	6F	AL	30,56	29,80	36	12,8	20,6	22	-	15	0,032
36 3M 9	36	6F	AL	34,38	33,62	39	13,4	22,2	26	-	16	0,045
40 3M 9	40	6F	AL	38,20	37,44	42	13,4	22,2	28	-	18	0,055
44 3M 9	44	6F	AL	42,02	41,26	48	13,4	22,2	33	-	20	0,074
48 3M 9	48	6	AL	45,84	45,08	-	13,4	22,2	33	8	20	0,074
60 3M 9	60	6	AL	57,30	56,54	-	13,4	22,2	33	8	20	0,106
72 3M 9	72	6	AL	68,75	67,99	-	13,4	22,2	33	8	20	0,145
3M - Teilung 3 mm für Riemenbreite 15 mm												
10 3M 15	10	1F	AL	9,55	8,79	13	17	26	13	-	3	0,006
12 3M 15	12	1F	AL	11,46	10,70	15	17	26	15	-	5	0,008



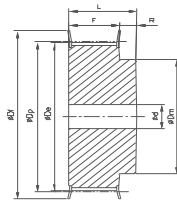

Ausf. 6F

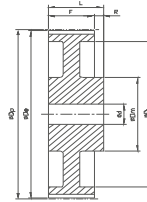

Ausf. 6W

Bezeichnung	Anzahl der Zähne	Ausführung	Material	D _p (mm)	D _c (mm)	D _i (mm)	D _i (mm)	F (mm)	L (mm)	D _m (mm)	Vorbohrung d (mm)	Fertigbohrung d _{max} (mm)	Gewicht (=kg)
5M - Teilung 5 mm für Riemenbreite 9 mm													
12 5M 9	12	6F	ST	19,10	17,96	23	-	14,5	20	12	-	7	0,028
14 5M 9	14	6F	ST	22,28	21,14	25	-	14,5	20	13	-	8	0,034
15 5M 9	15	6F	ST	23,87	22,73	28	-	14,5	20	16	-	10	0,042
16 5M 9	16	6F	ST	25,46	24,32	28	-	14,5	20	16,2	-	10	0,050
18 5M 9	18	6F	ST	28,65	27,51	32	-	14,5	20	20	-	12	0,070
20 5M 9	20	6F	ST	31,83	30,69	36	-	14,5	22,5	23	-	14	0,094
21 5M 9	21	6F	ST	33,42	32,28	38	-	14,5	22,5	24	-	14	0,110
22 5M 9	22	6F	ST	35,01	33,87	39	-	14,5	22,5	25,5	-	14	0,118
24 5M 9	24	6F	ST	38,20	37,06	42	-	14,5	22,5	27	-	16	0,145
26 5M 9	26	6F	ST	41,38	40,24	44	-	14,5	22,5	30	-	18	0,170
28 5M 9	28	6F	ST	44,56	43,42	48	-	14,5	22,5	30,5	-	18	0,200
30 5M 9	30	6F	ST	47,75	46,61	51	-	14,5	22,5	35	-	20	0,236
32 5M 9	32	6F	ST	50,93	49,79	54	-	14,5	22,5	38	8	22	0,270
36 5M 9	36	6F	ST	57,30	56,16	60	-	14,5	22,5	38	8	22	0,324
40 5M 9	40	6F	ST	63,66	62,52	71	-	14,5	22,5	38	8	22	0,400
44 5M 9	44	6W	AL	70,03	68,89	-	54	14,5	25,5	38	8	22	0,170
48 5M 9	48	6W	AL	76,39	75,25	-	61	14,5	25,5	45	8	25	0,182
60 5M 9	60	6W	AL	95,49	94,35	-	80	14,5	25,5	45	8	25	0,230
72 5M 9	72	6W	AL	114,59	113,45	-	100	14,5	25,5	45	8	25	0,270
5M - Teilung 5 mm für Riemenbreite 15 mm													
12 5M 15	12	6F	ST	19,10	17,96	23	-	20,5	20,5	13	-	7	0,034
14 5M 15	14	6F	ST	22,28	21,14	25	-	20,5	20,5	14	-	8	0,046
15 5M 15	15	6F	ST	23,87	22,73	28	-	20,5	20,5	16	-	10	0,056
16 5M 15	16	6F	ST	25,46	24,32	28	-	20,5	20,5	16,5	-	10	0,064
18 5M 15	18	6F	ST	28,65	27,51	32	-	20,5	20,5	20	-	12	0,086
20 5M 15	20	6F	ST	31,83	30,69	36	-	20,5	20,5	23	-	14	0,112
21 5M 15	21	6F	ST	33,42	32,28	38	-	20,5	20,5	24	-	14	0,130
22 5M 15	22	6F	ST	35,01	33,87	39	-	20,5	20,5	25,5	-	14	0,140
24 5M 15	24	6F	ST	38,20	37,06	42	-	20,5	20,5	27	-	16	0,180
26 5M 15	26	6F	ST	41,38	40,24	44	-	20,5	20,5	30	-	18	0,220
28 5M 15	28	6F	ST	44,56	43,42	48	-	20,5	20,5	30,5	-	18	0,250
30 5M 15	30	6F	ST	47,75	46,61	51	-	20,5	20,5	35	-	20	0,300
32 5M 15	32	6F	ST	50,93	49,79	54	-	20,5	20,5	38	8	22	0,350
36 5M 15	36	6F	ST	57,30	56,16	60	-	20,5	20,5	38	8	22	0,426
40 5M 15	40	6F	ST	63,66	62,52	71	-	20,5	20,5	38	8	22	0,520
44 5M 15	44	6W	AL	70,03	68,89	-	54	20,5	20,5	38	8	22	0,225
48 5M 15	48	6W	AL	76,39	75,25	-	61	20,5	20,5	38	8	25	0,187
60 5M 15	60	6W	AL	95,49	94,35	-	80	20,5	20,5	50	8	25	0,305
72 5M 15	72	6W	AL	114,59	113,45	-	100	20,5	20,5	50	8	25	0,375
5M - Teilung 5 mm für Riemenbreite 25 mm													
12 5M 25	12	6F	ST	19,10	17,96	23	-	30,5	36	12	-	7	0,050
14 5M 25	14	6F	ST	22,28	21,14	25	-	30,5	36	13	-	8	0,070
15 5M 25	15	6F	ST	23,87	22,73	28	-	30,5	36	16	-	10	0,080
16 5M 25	16	6F	ST	25,46	24,32	28	-	30,5	36	16,5	-	10	0,100



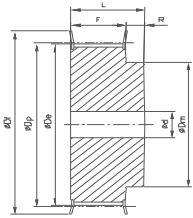

Ausf. 6F

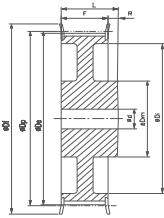

Ausf. 6WF

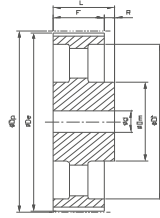

Ausf. 6A

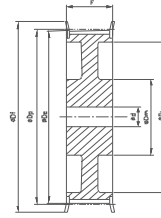

Ausf. 10WF

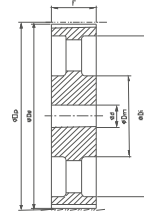

Ausf. 10A

Bezeichnung	Anzahl der Zähne	Ausführung	Material	D _p (mm)	D _e (mm)	D _f (mm)	F (mm)	L (mm)	D _m (mm)	D _i (mm)	Vorbohrung d (mm)	Fertigbohrung d _{max} (mm)
8M - Teilung 8 mm für Riemenbreite 20 mm												
22 8M 20	22	6F	ST	56,02	54,65	60	28	38	43	-	12	30
24 8M 20	24	6F	ST	61,12	59,75	66	28	38	45	-	12	30
26 8M 20	26	6F	ST	66,21	64,84	70	28	38	48	-	12	35
28 8M 20	28	6F	ST	71,30	70,08	75	28	38	50	-	15	35
30 8M 20	30	6F	ST	76,39	75,13	83	28	38	55	-	15	35
32 8M 20	32	6F	ST	81,49	80,16	87	28	38	60	-	15	40
34 8M 20	34	6F	ST	86,58	85,22	91	28	38	70	-	15	45
36 8M 20	36	6F	ST	91,67	90,30	97	28	38	75	-	15	45
38 8M 20	38	6F	ST	96,77	95,39	102	28	38	75	-	15	45
40 8M 20	40	6F	ST	101,86	100,49	106	28	38	75	-	15	45
44 8M 20	44	6F	ST	112,05	110,67	120	28	38	75	-	15	45
48 8M 20	48	6F	ST	122,23	120,86	127	28	38	75	-	15	45
56 8M 20	56	6WF	ST	142,60	141,23	150	28	38	80	116	15	45
64 8M 20	64	6WF	ST	162,97	161,60	168	28	38	80	137	15	45
72 8M 20	72	6WF	ST	183,35	181,97	192	28	38	80	158	15	45
80 8M 20	80	6W	GG	203,72	202,35	-	28	38	90	180	15	50
90 8M 20	90	6A	GG	229,18	227,81	-	28	38	90	204	15	50
112 8M 20	112	6A	GG	285,21	283,83	-	28	38	90	254	18	50
144 8M 20	144	6A	GG	366,69	365,32	-	28	38	90	336	20	50
168 8M 20	168	6A	GG	427,81	426,44	-	28	38	100	400	20	55
192 8M 20	192	6A	GG	488,92	487,55	-	28	38	100	460	20	55
8M - Teilung 8 mm für Riemenbreite 30 mm												
22 8M 30	22	6F	ST	56,02	54,65	60	38	48	43	-	12	30
24 8M 30	24	6F	ST	61,12	59,75	66	38	48	45	-	12	30
26 8M 30	26	6F	ST	66,21	64,84	70	38	48	48	-	12	35
28 8M 30	28	6F	ST	71,30	70,08	75	38	48	50	-	15	35
30 8M 30	30	6F	ST	76,39	75,13	83	38	48	55	-	15	35
32 8M 30	32	6F	ST	81,49	80,16	87	38	48	60	-	15	40
34 8M 30	34	6F	ST	86,58	85,22	91	38	48	70	-	15	45
36 8M 30	36	6F	ST	91,67	90,30	97	38	48	75	-	15	45
38 8M 30	38	6F	ST	96,77	95,39	102	38	48	75	-	15	45
40 8M 30	40	6F	ST	101,86	100,49	106	38	48	75	-	15	45
44 8M 30	44	6F	ST	112,05	110,67	120	38	48	75	-	15	45
48 8M 30	48	6F	ST	122,23	120,86	128	38	48	75	-	15	45
56 8M 30	56	6WF	ST	142,60	141,23	150	38	48	90	116	15	50
64 8M 30	64	6WF	ST	162,97	161,60	168	38	48	90	137	15	50
72 8M 30	72	6WF	ST	183,35	181,97	192	38	48	95	158	15	50
80 8M 30	80	6W	GG	203,72	202,35	-	38	48	100	180	15	55
90 8M 30	90	6A	GG	229,18	227,81	-	38	48	100	204	15	55
112 8M 30	112	6A	GG	285,21	283,83	-	38	48	100	254	18	55
144 8M 30	144	6A	GG	366,69	365,32	-	38	48	100	336	20	55
168 8M 30	168	6A	GG	427,81	426,44	-	38	48	100	400	20	55
192 8M 30	192	6A	GG	488,92	487,55	-	38	48	100	460	20	55



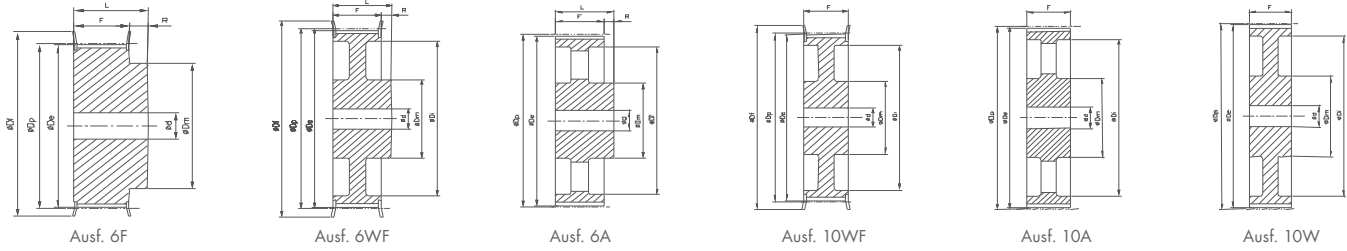

Bezeichnung	Anzahl der Zähne	Ausführung	Material	D _p (mm)	D _e (mm)	D _i (mm)	F (mm)	L (mm)	D _m (mm)	D _i (mm)	Vorbohrung d (mm)	Fertigbohrung d _{max} (mm)	Gewicht (≈kg)
14M - Teilung 14 mm für Riemenbreite 40 mm													
28 14M 40	28	6F	ST	124,78	122,12	128	54	69	100	-	24	60	4,730
29 14M 40	29	6F	ST	129,23	126,57	138	54	69	100	-	24	60	5,090
30 14M 40	30	6F	ST	133,69	130,99	138	54	69	100	-	24	60	5,450
32 14M 40	32	6F	ST	142,60	139,88	154	54	69	100	-	24	70	6,170
34 14M 40	34	6F	ST	151,52	148,79	160	54	69	100	-	24	70	6,880
36 14M 40	36	6F	ST	160,43	157,68	168	54	69	100	-	24	70	7,600
38 14M 40	38	6F	ST	169,34	166,60	183	54	69	120	-	24	70	8,280
40 14M 40	40	6F	ST	178,25	175,49	188	54	69	120	-	24	70	9,260
44 14M 40	44	6F	ST	196,08	193,28	211	54	69	120	-	24	70	10,320
48 14M 40	48	6WF	GG	213,90	211,11	226	54	69	135	170	24	70	11,500
56 14M 40	56	6WF	GG	249,55	246,76	256	54	69	135	207	28	70	13,050
64 14M 40	64	6WF	GG	285,21	282,41	296	54	69	135	240	28	70	14,400
72 14M 40	72	6A	GG	320,86	318,06	-	54	69	135	280	28	70	16,900
80 14M 40	80	6A	GG	356,51	353,71	-	54	69	135	314	28	70	18,500
90 14M 40	90	6A	GG	401,07	398,28	-	54	69	135	358	28	70	20,000
112 14M 40*	112	6A	GG	499,11	496,32	-	54	69	135	456	28	70	26,700
144 14M 40*	144	6A	GG	641,71	638,92	-	54	69	135	600	28	70	35,000
168 14M 40*	168	6A	GG	748,66	745,87	-	54	69	135	706	28	70	44,200
192 14M 40*	192	6A	GG	855,62	852,82	-	54	69	135	813	28	70	52,200
216 14M 40*	216	6A	GG	962,57	959,76	-	54	69	150	920	28	80	60,000
14M - Teilung 14 mm für Riemenbreite 55 mm													
28 14M 55	28	6F	ST	124,78	122,12	128	70	85	100	-	24	60	5,600
29 14M 55	29	6F	ST	129,23	126,57	138	70	85	100	-	24	60	6,100
30 14M 55	30	6F	ST	133,69	130,99	138	70	85	100	-	24	60	6,600
32 14M 55	32	6F	ST	142,60	139,88	154	70	85	100	-	24	70	7,600
34 14M 55	34	6F	ST	151,52	148,79	160	70	85	100	-	24	70	8,600
36 14M 55	36	6F	ST	160,43	157,68	168	70	85	100	-	24	70	9,600
38 14M 55	38	6F	ST	169,34	166,60	183	70	85	120	-	24	70	10,800
40 14M 55	40	6F	ST	178,25	175,49	188	70	85	120	-	24	70	11,200
44 14M 55	44	6F	ST	196,08	193,28	211	70	85	120	-	24	70	12,500
48 14M 55	48	10WF	GG	213,90	211,11	226	70	70	135	170	24	70	13,700
56 14M 55	56	10WF	GG	249,55	246,76	256	70	70	135	207	28	70	14,500
64 14M 55	64	10WF	GG	285,21	282,41	296	70	70	135	240	28	70	15,600
72 14M 55	72	10A	GG	320,86	318,06	-	70	70	135	280	28	70	18,500
80 14M 55	80	10A	GG	356,51	353,71	-	70	70	135	314	28	70	20,000
90 14M 55	90	10A	GG	401,07	398,28	-	70	70	135	358	28	70	22,600
112 14M 55*	112	10A	GG	499,11	496,32	-	70	70	135	456	28	70	29,500
144 14M 55*	144	10A	GG	641,71	638,92	-	70	70	135	600	28	70	39,000
168 14M 55*	168	10A	GG	748,66	745,87	-	70	70	135	706	28	70	48,500
192 14M 55*	192	10A	GG	855,62	852,82	-	70	70	135	813	28	70	57,800
216 14M 55*	216	10A	GG	962,57	959,76	-	70	70	150	920	28	80	67,000
14M - Teilung 14 mm für Riemenbreite 85 mm													
28 14M 85	28	6F	ST	124,78	122,12	128	102	202	100	-	24	60	7,700



Bezeichnung	Anzahl der Zähne	Ausführung	Material	D _p (mm)	D _e (mm)	D _i (mm)	F (mm)	L (mm)	D _m (mm)	D _i (mm)	Vorbohrung d (mm)	Fertigbohrung d _{max} (mm)	Gewicht (=kg)
29 14M 85	29	6F	ST	129,23	126,57	138	102	117	100	-	24	60	8,400
30 14M 85	30	6F	ST	133,69	130,99	138	102	117	100	-	24	60	9,100
32 14M 85	32	6F	ST	142,60	139,88	154	102	117	100	-	24	60	10,500
34 14M 85	34	6F	ST	151,52	148,79	160	102	117	100	-	24	70	11,900
36 14M 85	36	6F	ST	160,43	157,68	168	102	117	100	-	32	70	13,200
38 14M 85	38	6F	ST	169,34	166,60	183	102	117	120	-	32	70	15,150
40 14M 85	40	6F	ST	178,25	175,49	188	102	117	135	-	32	70	17,100
44 14M 85	44	6F	ST	196,08	193,28	211	102	117	135	-	32	70	23,300
48 14M 85	48	6F	ST	213,90	211,11	226	102	117	150	-	32	80	25,000
56 14M 85	56	10WF	GG	249,55	246,76	256	102	102	150	207	32	80	25,000
64 14M 85	64	10WF	GG	285,21	282,41	296	102	102	150	242	32	80	28,200
72 14M 85	72	10A	GG	320,86	318,06	-	102	102	150	278	32	80	28,800
80 14M 85	80	10A	GG	356,51	353,71	-	102	102	150	314	32	80	30,100
90 14M 85	90	10A	GG	401,07	398,28	-	102	102	150	358	32	80	33,000
112 14M 85*	112	10A	GG	499,11	496,32	-	102	102	150	456	32	80	41,800
144 14M 85*	144	10A	GG	641,71	638,92	-	102	102	150	600	32	80	52,400
168 14M 85*	168	10A	GG	748,66	745,87	-	102	102	150	706	32	80	60,300
192 14M 85*	192	10A	GG	855,62	852,82	-	102	102	165	813	32	90	70,200
216 14M 85*	216	10A	GG	962,57	959,76	-	102	102	160	920	32	90	81,000
14M - Teilung 14 mm für Riemenbreite 115 mm													
28 14M 115	28	6F	ST	124,78	122,12	128	133	148	100	-	32	60	9,200
29 14M 115	29	6F	ST	129,23	126,57	138	133	148	100	-	32	60	10,200
30 14M 115	30	6F	ST	133,69	130,99	138	133	148	100	-	32	60	11,200
32 14M 115	32	6F	ST	142,60	139,88	154	133	148	100	-	32	60	13,200
34 14M 115	34	6F	ST	151,52	148,79	160	133	148	100	-	32	70	14,800
36 14M 115	36	6F	ST	160,43	157,68	168	133	148	120	-	32	70	16,600
38 14M 115	38	6F	ST	169,34	166,60	183	133	148	120	-	32	70	19,200
40 14M 115	40	6F	ST	178,25	175,49	188	133	148	135	-	32	70	22,100
44 14M 115	44	6F	ST	196,08	193,28	211	133	148	140	-	32	80	28,000
48 14M 115	48	6F	ST	213,90	211,11	226	133	148	150	-	32	80	35,000
56 14M 115	56	6F	ST	249,55	246,76	256	133	148	150	-	32	80	44,200
64 14M 115	64	10WF	GG	285,21	282,41	296	133	133	150	240	32	80	36,800
72 14M 115	72	10A	GG	320,86	318,06	-	133	133	150	278	32	80	36,100
80 14M 115	80	10A	GG	356,51	353,71	-	133	133	150	314	32	80	38,600
90 14M 115	90	10A	GG	401,07	398,28	-	133	133	150	358	32	80	41,000
112 14M 115*	112	10A	GG	499,11	496,32	-	133	133	150	456	32	80	54,400
144 14M 115*	144	10A	GG	641,71	638,92	-	133	133	165	600	32	90	67,800
168 14M 115*	168	10A	GG	748,66	745,87	-	133	133	165	706	32	90	75,800
192 14M 115*	192	10A	GG	855,62	852,82	-	133	133	165	813	32	90	88,300
216 14M 115*	216	10A	GG	962,57	959,76	-	133	133	165	920	32	90	98,000
14M - Teilung 14 mm für Riemenbreite 170 mm													
28 14M 170*	28	6F	ST	124,78	122,12	128	187	202	100	-	32	60	13,800
29 14M 170*	29	6F	ST	129,23	126,57	138	187	202	100	-	32	60	14,200
30 14M 170*	30	6F	ST	133,69	130,99	138	187	202	100	-	32	60	15,600
32 14M 170*	32	6F	ST	142,60	139,88	154	187	202	100	-	32	60	18,100
34 14M 170*	34	6F	ST	151,52	148,79	160	187	202	100	-	32	60	20,400
36 14M 170*	36	6F	ST	160,43	157,68	168	187	202	100	-	32	70	23,500
38 14M 170*	38	6F	ST	169,34	166,60	183	187	202	120	-	32	70	26,500
40 14M 170*	40	6F	ST	178,25	175,49	188	187	202	135	-	32	85	30,100
44 14M 170*	44	6F	ST	196,08	193,28	211	187	202	140	-	32	85	37,800
48 14M 170*	48	6F	ST	213,90	211,11	226	187	202	150	-	32	85	44,500

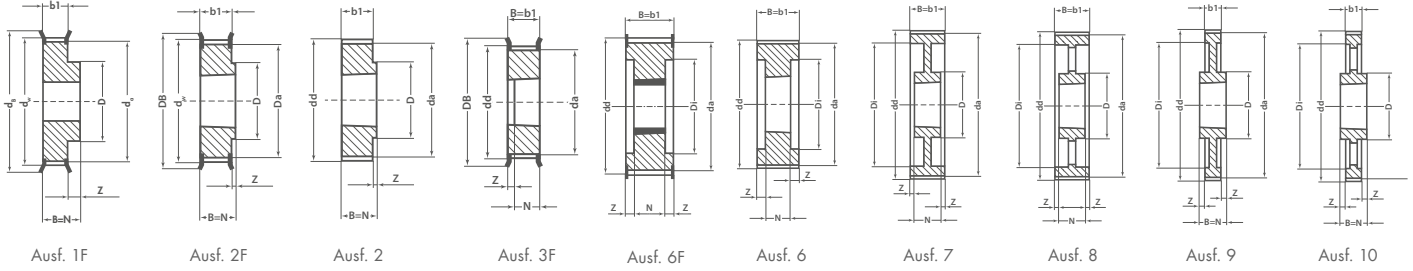

Bezeichnung	Anzahl der Zähne	Ausführung	Material	D ₁ (mm)	D ₂ (mm)	D ₃ (mm)	B ₁ (mm)	B (mm)	N (mm)	D (mm)	D ₁ (mm)	Z (mm)	Fertigbohrung d _{max} (mm)	Taperbuchse	Gewicht ohne Buchse (≈kg)
8MDC															
8MDC 12 TB 25	25	2F	ST	63,66	62,06	70,0	20,0	22,0	22,0	49	-	-	28	1108	0,300
8MDC 12 TB 28	28	2F	ST	71,30	69,70	75,0	20,0	22,0	22,0	56	-	-	28	1108	0,400
8MDC 12 TB 30	30	2F	ST	76,39	74,79	83,0	20,0	25,0	25,0	60	-	-	32	1210	0,400
8MDC 12 TB 32	32	2F	ST	81,49	79,89	87,0	20,0	25,0	25,0	66	-	-	42	1610	0,400
8MDC 12 TB 34	34	2F	ST	86,58	84,98	91,0	20,0	25,0	25,0	68	-	-	42	1610	0,500
8MDC 12 TB 36	36	2F	ST	91,67	90,07	97,0	20,0	25,0	25,0	74	-	-	42	1610	0,600
8MDC 12 TB 38	38	2F	ST	96,77	95,17	102,0	20,0	25,0	25,0	80	-	-	42	1610	0,700
8MDC 12 TB 40	40	2F	ST	101,86	100,26	106,0	20,0	25,0	25,0	85	-	-	42	1610	0,900
8MDC 12 TB 45	45	2F	ST	114,59	112,99	120,0	20,0	32,0	32,0	92	-	-	50	2012	1,100
8MDC 12 TB 48	48	2F	ST	122,23	120,63	128,0	20,0	32,0	32,0	100	-	-	50	2012	1,500
8MDC 12 TB 50	50	2F	ST	127,32	125,72	135,0	20,0	32,0	32,0	104	-	-	50	2012	1,600
8MDC 12 TB 56	56	2F	ST	142,60	141,00	150,0	20,0	32,0	32,0	104	-	-	50	2012	2,100
8MDC 12 TB 60	60	2F	ST	152,79	151,19	158,0	20,0	32,0	32,0	111	-	-	50	2012	2,400
8MDC 12 TB 64	64	2F	ST	162,97	161,37	168,0	20,0	32,0	32,0	111	-	-	50	2012	2,700
8MDC 12 TB 75	75	2	GG	190,99	189,39	-	20,0	32,0	32,0	111	-	-	50	2012	4,600
8MDC 12 TB 80	80	2	GG	203,72	202,12	-	20,0	32,0	32,0	111	-	-	50	2012	5,100
8MDC 12 TB 90	90	2	GG	229,18	227,58	-	20,0	-	-	111	-	-	50	2012	6,400
8MDC 21 TB 25	25	3F	ST	63,66	62,06	70,0	30,0	30,0	22,0	-	-	8,0	28	1108	0,400
8MDC 21 TB 28	28	3F	ST	71,30	69,70	75,0	30,0	30,0	25,0	-	-	5,0	32	1210	0,400
8MDC 21 TB 30	30	3F	ST	76,39	74,79	86,0	30,0	30,0	25,0	-	-	5,0	32	1210	0,600
8MDC 21 TB 32	32	3F	ST	81,49	79,89	90,0	30,0	30,0	25,0	-	-	5,0	42	1610	0,500
8MDC 21 TB 34	34	3F	ST	86,58	84,98	91,0	30,0	30,0	25,0	-	-	5,0	42	1610	0,600
8MDC 21 TB 36	36	3F	ST	91,67	90,07	98,0	30,0	30,0	25,0	-	-	5,0	42	1610	0,700
8MDC 21 TB 38	38	3F	ST	96,77	95,17	106,0	30,0	30,0	25,0	-	-	5,0	42	1610	1,000
8MDC 21 TB 40	40	3F	ST	101,86	100,26	111,0	30,0	30,0	25,0	-	-	5,0	42	1610	1,100
8MDC 21 TB 45	45	2F	ST	114,59	112,99	119,0	30,0	32,0	32,0	92	-	-	50	2012	1,300
8MDC 21 TB 48	48	2F	ST	122,23	120,63	135,0	30,0	32,0	32,0	100	-	-	50	2012	1,600
8MDC 21 TB 50	50	2F	ST	127,32	125,72	135,0	30,0	32,0	32,0	104	-	-	50	2012	1,900
8MDC 21 TB 56	56	2F	ST	142,60	141,00	150,0	30,0	32,0	32,0	111	-	-	50	2012	2,400
8MDC 21 TB 60	60	2F	ST	152,79	151,19	159,0	30,0	45,0	45,0	124	-	-	60	2517	3,200
8MDC 21 TB 64	64	2F	ST	162,97	161,37	168,0	30,0	45,0	45,0	124	-	-	60	2517	3,800
8MDC 21 TB 75	75	2	GG	190,99	189,39	-	30,0	45,0	45,0	124	-	-	60	2517	6,800
8MDC 21 TB 80	80	2	GG	203,72	202,12	-	30,0	45,0	45,0	124	-	-	60	2517	7,600
8MDC 21 TB 90	90	9	GG	229,18	227,58	-	30,0	45,0	45,0	124	198	7,5	60	2517	8,600
8MDC 21 TB 112	112	9	GG	285,21	283,61	-	30,0	45,0	45,0	124	253	7,5	60	2517	12,500
8MDC 21 TB 140	140	10	GG	356,51	354,91	-	30,0	51,0	51,0	150	324	10,5	75	3020	12,800
8MDC 36 TB 28	28	3F	ST	71,30	69,70	75,0	45,0	45,0	25,0	-	-	20,0	32	1210	0,700
8MDC 36 TB 30	30	3F	ST	76,39	74,79	83,0	45,0	45,0	25,0	-	-	20,0	42	1610	0,600
8MDC 36 TB 32	32	3F	ST	81,89	79,89	87,0	45,0	45,0	25,0	-	-	20,0	42	1610	0,800
8MDC 36 TB 34	34	3F	ST	86,58	84,98	91,0	45,0	45,0	25,0	-	-	20,0	42	1610	1,000
8MDC 36 TB 36	36	3F	ST	91,67	90,07	97,0	45,0	45,0	25,0	-	-	20,0	42	1610	1,200
8MDC 36 TB 38	38	3F	ST	96,77	95,17	102,0	45,0	45,0	25,0	-	-	20,0	42	1610	1,400
8MDC 36 TB 40	40	3F	ST	101,86	100,26	106,0	45,0	45,0	32,0	-	-	13,0	50	2012	1,400

optibelt ZRS DELTA CHAIN-Zahnscheiben für Taper-Buchsen Profil 8MDC



Bezeichnung	Anzahl der Zähne	Ausführung	Material	D _a (mm)	D _e (mm)	D _s (mm)	B ₁ (mm)	B (mm)	N (mm)	D (mm)	D _i (mm)	Z (mm)	Fertigbohrung d _{max} (mm)	Taperbuchse	Gewicht ohne Buchse (≈kg)
8MDC 36 TB 45	45	3F	ST	114,59	112,99	120,0	45,0	45,0	32,0	-	-	13,0	50	2012	1,900
8MDC 36 TB 48	48	3F	ST	122,23	120,63	128,0	45,0	45,0	32,0	-	-	13,0	50	2012	2,200
8MDC 36 TB 50	50	3F	ST	127,32	125,72	128,0	45,0	45,0	32,0	-	-	13,0	50	2012	2,700
8MDC 36 TB 56	56	3F	ST	142,60	141,00	150,0	45,0	45,0	45,0	-	-	-	60	2517	3,000
8MDC 36 TB 60	60	3F	ST	152,79	151,19	158,0	45,0	45,0	45,0	-	-	-	60	2517	3,800
8MDC 36 TB 64	64	3F	ST	162,97	161,37	168,0	45,0	45,0	45,0	-	-	-	60	2517	4,500
8MDC 36 TB 75	75	2	GG	190,99	189,39	-	45,0	51,0	51,0	150	-	-	75	3020	8,700
8MDC 36 TB 80	80	2	GG	203,72	202,12	-	45,0	51,0	51,0	150	-	-	75	3020	10,000
8MDC 36 TB 90	90	9	GG	229,18	227,58	-	45,0	51,0	51,0	150	197	3,0	75	3020	10,400
8MDC 36 TB 112	112	9	GG	285,21	283,61	-	45,0	51,0	51,0	150	253	3,0	75	3020	14,000
8MDC 36 TB 140	140	10	GG	356,51	354,91	-	45,0	51,0	51,0	150	324	3,0	75	3020	12,000
8MDC 36 TB 168	168	10	GG	427,81	426,21	-	45,0	65,0	65,0	198	396	10,0	100	3525	23,900
8MDC 36 TB 192	192	10	GG	488,92	487,32	-	45,0	65,0	65,0	198	457	10,0	100	3525	26,600
8MDC 62 TB 40	40	3F	ST	101,86	100,26	106,0	72,0	72,0	32,0	-	-	40,0	50	2012	2,100
8MDC 62 TB 45	45	3F	ST	114,59	112,99	120,0	72,0	72,0	32,0	-	-	40,0	50	2012	3,300
8MDC 62 TB 48	48	3F	ST	122,23	120,63	128,0	72,0	72,0	45,0	-	-	27,0	60	2517	3,900
8MDC 62 TB 50	50	3F	ST	127,32	125,72	135,0	72,0	72,0	45,0	-	-	27,0	60	2517	4,700
8MDC 62 TB 56	56	6F	ST	142,60	141,00	149,0	72,0	72,0	45,0	-	111	13,5	60	2517	5,500
8MDC 62 TB 60	60	6F	ST	152,79	151,19	157,0	72,0	72,0	45,0	-	121	13,5	60	2517	6,400
8MDC 62 TB 64	64	6F	ST	162,97	161,37	168,0	72,0	72,0	45,0	-	131	13,5	60	2517	7,200
8MDC 62 TB 75	75	6	GG	190,99	189,39	-	72,0	72,0	51,0	-	159	10,5	75	3020	10,000
8MDC 62 TB 80	80	6	GG	203,72	202,12	-	72,0	72,0	51,0	-	172	10,5	45	3020	11,500
8MDC 62 TB 90	90	6	GG	229,18	227,58	-	72,0	72,0	51,0	-	197	10,5	75	3020	15,000
8MDC 62 TB 112	112	7	GG	285,21	283,61	-	72,0	72,0	51,0	150	253	10,5	75	3020	15,000
8MDC 62 TB 140	140	7	GG	356,51	354,91	-	72,0	72,0	65,0	198	324	3,5	100	3525	24,800
8MDC 62 TB 168	168	8	GG	427,81	426,21	-	72,0	72,0	65,0	198	396	3,5	100	3525	28,400
8MDC 62 TB 192	192	8	GG	488,92	487,32	-	72,0	72,0	65,0	198	457	3,5	100	3525	32,200

Taper-Buchse	1008	1108	1210	1610	2012	2517	3020	3525
Bohrung d ₂ von... bis...	10-25	10-28	11-32	14-42	14-50	16-65	25-75	35-90

GG = Grauguss ST = Stahl **Fertigungstechnische Änderungen vorbehalten.** * Keine Lagerware Profil 14MDC auf Anfrage
Bohrungsdurchmesser d₂ siehe Seite 4.

optibelt ZRS DELTA CHAIN-Zahnscheiben für zylindrische Bohrung Profil 8MDC

Bezeichnung	Anzahl der Zähne	Ausführung	Material	D _a (mm)	D _e (mm)	D _s (mm)	B ₁ (mm)	B (mm)	N (mm)	D (mm)	Vorbohrung d (mm)	Fertigbohrung d _{max} (mm)	Gewicht (≈kg)
8MDC													
8MDC 12 22	22	1F	ST	56,02	54,42	63,0	20,0	30,0	30,0	43	12	28	0,500
8MDC 21 22	22	1F	ST	56,02	54,42	60,0	30,0	40,0	40,0	43	12	28	0,600
8MDC 36 25	25	1F	ST	63,66	62,06	70,0	45,0	55,0	55,0	49	12	32	1,100
8MDC 62 30	30	1F	ST	76,39	74,79	83,0	72,0	84,0	84,0	62	15	42	2,500
8MDC 62 32	32	1F	ST	81,49	79,89	87,0	72,0	84,0	84,0	65	15	50	2,800
8MDC 62 34	34	1F	ST	86,58	84,98	91,0	72,0	84,0	84,0	70	15	55	3,000
8MDC 62 36	36	1F	ST	91,67	90,07	97,0	72,0	84,0	84,0	75	15	60	3,400
8MDC 62 38	38	1F	ST	96,77	95,17	102,0	72,0	84,0	84,0	75	15	60	3,800

GG = Grauguss ST = Stahl **Fertigungstechnische Änderungen vorbehalten.** * Keine Lagerware Profil 14MDC auf Anfrage



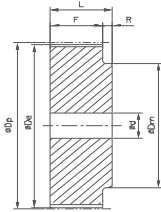

Ausf. 6

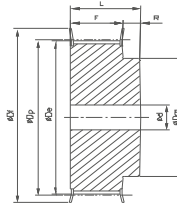

Ausf. 6F

Bezeichnung	Anzahl der Zähne	Ausführung	Material	D _p (mm)	D _e (mm)	D _i (mm)	F (mm)	L (mm)	D _m (mm)	Vorbohrung d (mm)	Fertigbohrung d _{max} (mm)	Gewicht (=kg)
T5 - Teilung 5 mm für Riemenbreite 10 mm												
21 T5 / 10-2	10	6F	AL	15,92	15,05	19,5	15	21	8	-	5	0,012
21 T5 / 12-2	12	6F	AL	19,10	18,25	23	15	21	11	-	6	0,016
21 T5 / 14-2	14	6F	AL	22,29	21,45	25	15	21	13	-	8	0,019
21 T5 / 15-2	15	6F	AL	23,88	23,05	28	15	21	16	-	10	0,021
21 T5 / 16-2	16	6F	AL	25,47	24,60	32	15	21	18	-	11	0,025
21 T5 / 18-2	18	6F	AL	28,65	27,80	32	15	21	20	-	12	0,031
21 T5 / 19-2	19	6F	AL	30,25	29,40	36	15	21	20	-	12	0,036
21 T5 / 20-2	20	6F	AL	31,83	31,00	36	15	21	22	-	14	0,038
21 T5 / 22-2	22	6F	AL	35,12	34,25	38	15	21	23	-	15	0,046
21 T5 / 24-2	24	6F	AL	38,21	37,40	42	15	21	24	-	15	0,054
21 T5 / 25-2	25	6F	AL	39,80	39,00	44	15	21	26	-	15	0,058
21 T5 / 26-2	26	6F	AL	41,39	40,60	44	15	21	26	-	16	0,062
21 T5 / 27-2	27	6F	AL	42,98	42,20	48	15	21	30	8	18	0,064
21 T5 / 28-2	28	6F	AL	44,58	43,75	48	15	21	32	8	18	0,071
21 T5 / 30-2	30	6F	AL	47,76	46,95	51	15	21	34	8	18	0,075
21 T5 / 32-2	32	6F	AL	50,94	50,10	54	15	21	38	8	22	0,088
21 T5 / 36-2	36	6F	AL	57,31	56,45	64	15	21	38	8	22	0,114
21 T5 / 40-2	40	6F	AL	63,66	62,85	66,5	15	21	40	8	23	0,138
21 T5 / 42-2	42	6F	AL	66,87	66,00	70	15	21	40	8	24	0,180
21 T5 / 44-0	44	6	AL	70,07	69,20	-	15	21	45	8	26	0,185
21 T5 / 48-0	48	6	AL	76,42	75,55	-	15	21	50	8	28	0,200
21 T5 / 60-0	60	6	AL	95,52	94,65	-	15	21	65	8	35	0,307
T5 - Teilung 5 mm für Riemenbreite 16 mm												
27 T5 / 10-2	10	6F	AL	15,92	15,05	19,5	21	27	8	-	5	0,016
27 T5 / 12-2	12	6F	AL	19,01	18,25	23	21	27	11	-	6	0,022
27 T5 / 14-2	14	6F	AL	22,29	21,45	25	21	27	13	-	8	0,026
27 T5 / 15-2	15	6F	AL	23,88	23,05	28	21	27	16	-	10	0,029
27 T5 / 16-2	16	6F	AL	25,47	24,60	32	21	27	18	-	11	0,035
27 T5 / 18-2	18	6F	AL	28,65	27,80	32	21	27	20	-	12	0,043
27 T5 / 19-2	19	6F	AL	30,25	29,40	36	21	27	20	-	12	0,049
27 T5 / 20-2	20	6F	AL	31,83	31,00	36	21	27	22	-	14	0,053
27 T5 / 22-2	22	6F	AL	35,12	34,25	38	21	27	23	-	15	0,054
27 T5 / 24-2	24	6F	AL	38,21	37,40	42	21	27	24	-	15	0,076
27 T5 / 25-2	25	6F	AL	39,80	39,00	44	21	27	26	-	15	0,081
27 T5 / 26-2	26	6F	AL	41,47	40,60	44	21	27	26	-	16	0,085
27 T5 / 27-2	27	6F	AL	42,98	42,20	48	21	27	30	8	18	0,090
27 T5 / 28-2	28	6F	AL	44,62	43,75	48	21	27	32	8	18	0,092
27 T5 / 30-2	30	6F	AL	47,76	46,95	51	21	27	34	8	18	0,105
27 T5 / 32-2	32	6F	AL	50,94	50,10	54	21	27	38	8	22	0,123
27 T5 / 36-2	36	6F	AL	57,31	56,45	64	21	27	38	8	22	0,160
27 T5 / 40-2	40	6F	AL	63,66	62,85	66,5	21	27	40	8	23	0,193
27 T5 / 42-2	42	6F	AL	66,87	66,00	70	21	27	40	8	24	0,205
27 T5 / 44-0	44	6	AL	70,07	69,20	-	21	27	45	8	26	0,228
27 T5 / 48-0	48	6	AL	76,42	75,55	-	21	27	50	8	28	0,280



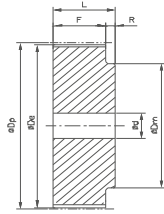

Ausf. 6

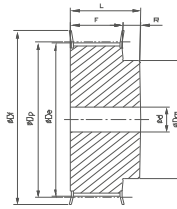

Ausf. 6F

Bezeichnung	Anzahl der Zähne	Ausführung	Material	D _p (mm)	D _e (mm)	D _f (mm)	F (mm)	L (mm)	D _m (mm)	Vorbohrung d (mm)	Fertigbohrung d _{max} (mm)	Gewicht (=kg)
T10 - Teilung 10 mm für Riemenbreite 16 mm												
31 T10 / 12-2	12	6F	AL	38,20	36,35	42	21	31	28	6	16	0,076
31 T10 / 14-2	14	6F	AL	44,56	42,70	48	21	31	32	8	18	0,104
31 T10 / 15-2	15	6F	AL	47,75	45,90	51	21	31	32	8	18	0,116
31 T10 / 16-2	16	6F	AL	50,93	49,10	54	21	31	35	8	20	0,134
31 T10 / 18-2	18	6F	AL	57,29	55,45	60	21	31	40	8	22	0,167
31 T10 / 19-2	19	6F	AL	60,48	58,60	66,5	21	31	44	8	22	0,184
31 T10 / 20-2	20	6F	AL	63,66	61,80	66,5	21	31	46	8	24	0,208
31 T10 / 22-2	22	6F	AL	70,03	68,20	75	21	31	52	8	28	0,253
31 T10 / 24-2	24	6F	AL	76,39	74,55	83	21	31	58	8	30	0,288
31 T10 / 25-2	25	6F	AL	79,58	77,70	83	21	31	60	8	30	0,310
31 T10 / 26-2	26	6F	AL	82,76	80,90	87	21	31	60	8	30	0,357
31 T10 / 27-2	27	6F	AL	85,95	84,10	91	21	31	60	8	30	0,364
31 T10 / 28-2	28	6F	AL	89,12	87,25	93	21	31	60	8	30	0,401
31 T10 / 30-2	30	6F	AL	95,49	93,65	97	21	31	60	8	30	0,441
31 T10 / 32-2	32	6F	AL	101,86	100,00	106	21	31	65	10	32	0,493
31 T10 / 36-2	36	6F	AL	114,59	112,75	119	21	31	70	10	35	0,623
31 T10 / 40-2	40	6F	AL	127,32	125,45	131	21	31	80	10	40	0,767
31 T10 / 44-0	44	6	AL	140,05	138,20	-	21	31	88	10	46	0,993
31 T10 / 48-0	48	6	AL	152,78	150,95	-	21	31	95	16	48	1,090
31 T10 / 60-0	60	6	AL	190,98	189,10	-	21	31	110	16	60	1,710
T10 - Teilung 10 mm für Riemenbreite 25 mm												
40 T10 / 12-2	12	6F	AL	38,20	36,35	42	30	40	28	6	16	0,099
40 T10 / 14-2	14	6F	AL	44,56	42,70	48	30	40	32	8	18	0,134
40 T10 / 15-2	15	6F	AL	47,75	45,90	51	30	40	32	8	18	0,152
40 T10 / 16-2	16	6F	AL	50,93	49,10	54	30	40	35	8	20	0,176
40 T10 / 18-2	18	6F	AL	57,29	55,45	60	30	40	40	8	22	0,224
40 T10 / 19-2	19	6F	AL	60,48	58,65	66,5	30	40	44	8	22	0,247
40 T10 / 20-2	20	6F	AL	63,66	61,80	66,5	30	40	46	8	24	0,276
40 T10 / 22-2	22	6F	AL	70,03	68,20	75	30	40	52	8	28	0,337
40 T10 / 24-2	24	6F	AL	76,39	74,55	83	30	40	58	8	30	0,392
40 T10 / 25-2	25	6F	AL	79,58	77,75	83	30	40	60	8	30	0,422
40 T10 / 26-2	26	6F	AL	82,76	80,90	87	30	40	60	8	30	0,477
40 T10 / 27-2	27	6F	AL	85,95	84,10	91	30	40	60	8	30	0,536
40 T10 / 28-2	28	6F	AL	89,12	87,25	93	30	40	60	8	30	0,540
40 T10 / 30-2	30	6F	AL	95,49	93,65	97	30	40	60	8	30	0,640
40 T10 / 32-2	32	6F	AL	101,86	100,00	106	30	40	65	10	32	0,693
40 T10 / 36-2	36	6F	AL	114,59	112,75	119	30	40	70	10	35	0,873
40 T10 / 40-2	40	6F	AL	127,32	125,45	131	30	40	80	10	40	1,067
40 T10 / 44-0	44	6	AL	140,05	138,20	-	30	40	88	10	46	1,350
40 T10 / 48-0	48	6	AL	152,78	150,95	-	30	40	95	16	48	1,516
40 T10 / 60-0	60	6	AL	190,98	189,10	-	30	40	110	16	60	2,339
T10 - Teilung 10 mm für Riemenbreite 32 mm												
47 T10 / 18-2	18	6F	AL	57,29	55,45	60	37	47	40	10	22	0,253
47 T10 / 19-2	19	6F	AL	60,48	58,65	66,5	37	47	44	10	22	0,286



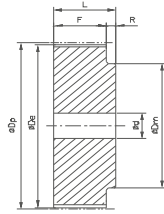

Ausf. 6

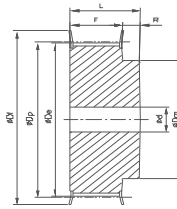

Ausf. 6F

Bezeichnung	Anzahl der Zähne	Ausführung	Material	D _p (mm)	D _e (mm)	D _i (mm)	F (mm)	L (mm)	D _m (mm)	Vorbohrung d (mm)	Fertigbohrung d _{max} (mm)	Gewicht (=kg)
AT5 - Teilung 5 mm für Riemenbreite 10 mm												
21 AT5 / 12-2	12	6F	AL	19,01	17,85	23	15	21	11	-	6	0,016
21 AT5 / 14-2	14	6F	AL	22,29	21,05	25	15	21	13	-	8	0,019
21 AT5 / 15-2	15	6F	AL	23,88	22,65	28	15	21	16	-	10	0,021
21 AT5 / 16-2	16	6F	AL	25,47	24,20	32	15	21	18	-	11	0,025
21 AT5 / 18-2	18	6F	AL	28,65	27,40	32	15	21	20	-	12	0,031
21 AT5 / 19-2	19	6F	AL	30,25	29,00	36	15	21	22	-	12	0,036
21 AT5 / 20-2	20	6F	AL	31,83	30,60	36	15	21	23	-	14	0,038
21 AT5 / 22-2	22	6F	AL	35,12	33,85	38	15	21	24	-	15	0,046
21 AT5 / 24-2	24	6F	AL	38,21	37,00	42	15	21	26	-	15	0,054
21 AT5 / 25-2	25	6F	AL	39,80	38,60	44	15	21	26	-	15	0,058
21 AT5 / 26-2	26	6F	AL	41,47	40,20	44	15	21	26	-	16	0,062
21 AT5 / 27-2	27	6F	AL	42,98	41,80	48	15	21	30	8	18	0,064
21 AT5 / 28-2	28	6F	AL	44,62	43,35	48	15	21	32	8	18	0,071
21 AT5 / 30-2	30	6F	AL	47,76	46,55	51	15	21	34	8	18	0,075
21 AT5 / 32-2	32	6F	AL	50,94	49,70	54	15	21	36	8	22	0,088
21 AT5 / 36-2	36	6F	AL	57,31	56,05	64	15	21	38	8	22	0,114
21 AT5 / 40-2	40	6F	AL	63,66	62,45	66,5	15	21	40	8	23	0,138
21 AT5 / 42-2	42	6F	AL	66,87	65,60	70	15	21	40	8	24	0,180
21 AT5 / 44-0	44	6	AL	70,07	68,80	-	15	21	45	8	26	0,185
21 AT5 / 48-0	48	6	AL	76,42	75,15	-	15	21	50	8	28	0,200
21 AT5 / 60-0	60	6	AL	95,52	94,25	-	15	21	65	8	35	0,307
AT5 - Teilung 5 mm für Riemenbreite 16 mm												
27 AT5 / 12-2	12	6F	AL	19,01	17,85	23	21	27	11	-	6	0,022
27 AT5 / 14-2	14	6F	AL	22,29	21,05	25	21	27	13	-	8	0,026
27 AT5 / 15-2	15	6F	AL	23,88	22,65	28	21	27	16	-	10	0,029
27 AT5 / 16-2	16	6F	AL	25,47	24,20	32	21	27	18	-	11	0,035
27 AT5 / 18-2	18	6F	AL	28,65	27,40	32	21	27	20	-	12	0,043
27 AT5 / 19-2	19	6F	AL	30,25	29,00	36	21	27	22	-	12	0,049
27 AT5 / 20-2	20	6F	AL	31,83	30,60	36	21	27	23	-	14	0,053
27 AT5 / 22-2	22	6F	AL	35,12	33,85	38	21	27	24	-	15	0,054
27 AT5 / 24-2	24	6F	AL	38,21	37,00	42	21	27	26	-	15	0,076
27 AT5 / 25-2	25	6F	AL	39,80	38,60	44	21	27	26	-	15	0,081
27 AT5 / 26-2	26	6F	AL	41,47	40,20	44	21	27	26	-	16	0,085
27 AT5 / 27-2	27	6F	AL	42,98	41,80	48	21	27	30	8	18	0,090
27 AT5 / 28-2	28	6F	AL	44,62	43,35	48	21	27	32	8	18	0,092
27 AT5 / 30-2	30	6F	AL	47,76	46,55	51	21	27	34	8	18	0,105
27 AT5 / 32-2	32	6F	AL	50,94	49,70	54	21	27	36	8	22	0,123
27 AT5 / 36-2	36	6F	AL	57,31	56,05	64	21	27	38	8	22	0,160
27 AT5 / 40-2	40	6F	AL	63,66	62,45	66,5	21	27	40	8	23	0,193
27 AT5 / 42-2	42	6F	AL	66,87	65,60	70	21	27	40	8	24	0,205
27 AT5 / 44-0	44	6	AL	70,07	68,80	-	21	27	45	8	26	0,228
27 AT5 / 48-0	48	6	AL	76,42	75,15	-	21	27	50	8	28	0,280
27 AT5 / 60-0	60	6	AL	95,52	94,25	-	21	27	65	8	35	0,430



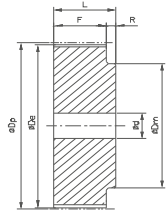

Ausf. 6

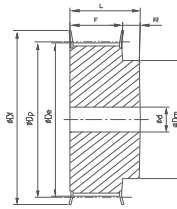

Ausf. 6F

Bezeichnung	Anzahl der Zähne	Ausführung	Material	D _p (mm)	D _e (mm)	D _i (mm)	L (mm)	F (mm)	D _m (mm)	Vorbohrung d (mm)	Fertigbohrung d _{max} (mm)	Gewicht (=kg)
AT10 - Teilung 10 mm für Riemenbreite 16 mm												
31 AT10 / 15-2	15	6F	AL	47,75	45,90	51	31	21	31	8	18	0,116
31 AT10 / 16-2	16	6F	AL	50,93	49,05	54	31	21	35	8	20	0,134
31 AT10 / 18-2	18	6F	AL	57,29	55,45	60	31	21	40	8	22	0,167
31 AT10 / 19-2	19	6F	AL	60,48	58,60	66,5	31	21	44	8	22	0,184
31 AT10 / 20-2	20	6F	AL	63,66	61,80	66,5	31	21	46	8	24	0,208
31 AT10 / 22-2	22	6F	AL	70,03	68,15	75	31	21	52	8	28	0,253
31 AT10 / 24-2	24	6F	AL	76,39	74,55	83	31	21	58	8	30	0,288
31 AT10 / 25-2	25	6F	AL	79,58	77,70	83	31	21	60	8	30	0,310
31 AT10 / 26-2	26	6F	AL	82,76	80,90	87	31	21	60	8	30	0,357
31 AT10 / 27-2	27	6F	AL	85,95	84,10	91	31	21	60	8	30	0,364
31 AT10 / 28-2	28	6F	AL	89,13	87,25	93	31	21	60	8	30	0,401
31 AT10 / 30-2	30	6F	AL	95,49	93,65	97	31	21	60	8	30	0,441
31 AT10 / 32-2	32	6F	AL	101,86	100,00	106	31	21	65	10	32	0,493
31 AT10 / 36-2	36	6F	AL	114,59	112,75	119	31	21	70	10	35	0,623
31 AT10 / 40-2	40	6F	AL	127,32	125,45	131	31	21	80	10	40	0,767
31 AT10 / 44-0	44	6	AL	140,06	138,20	-	31	21	88	10	46	0,993
31 AT10 / 48-0	48	6	AL	152,78	150,95	-	31	21	95	16	48	1,090
31 AT10 / 60-0	60	6	AL	190,98	189,10	-	31	21	110	16	60	1,710
AT10 - Teilung 10 mm für Riemenbreite 25 mm												
40 AT10 / 15-2	15	6F	AL	47,75	45,90	51	40	30	31	8	18	0,152
40 AT10 / 16-2	16	6F	AL	50,93	49,05	54	40	30	35	8	20	0,176
40 AT10 / 18-2	18	6F	AL	57,29	55,45	60	40	30	40	8	22	0,224
40 AT10 / 19-2	19	6F	AL	60,48	58,60	66,5	40	30	44	8	22	0,247
40 AT10 / 20-2	20	6F	AL	63,66	61,80	66,5	40	30	46	8	24	0,276
40 AT10 / 22-2	22	6F	AL	70,03	68,15	75	40	30	52	8	28	0,337
40 AT10 / 24-2	24	6F	AL	76,39	74,55	83	40	30	58	8	30	0,392
40 AT10 / 25-2	25	6F	AL	79,58	77,70	83	40	30	60	8	30	0,422
40 AT10 / 26-2	26	6F	AL	82,76	80,90	87	40	30	60	8	30	0,477
40 AT10 / 27-2	27	6F	AL	85,95	84,10	91	40	30	60	8	30	0,536
40 AT10 / 28-2	28	6F	AL	89,13	87,25	93	40	30	60	8	30	0,540
40 AT10 / 30-2	30	6F	AL	95,49	93,65	97	40	30	60	8	30	0,640
40 AT10 / 32-2	32	6F	AL	101,86	100,00	106	40	30	65	10	32	0,693
40 AT10 / 36-2	36	6F	AL	114,59	112,75	119	40	30	70	10	35	0,873
40 AT10 / 40-2	40	6F	AL	127,32	125,45	131	40	30	80	10	40	1,067
40 AT10 / 44-0	44	6	AL	140,06	138,20	-	40	30	88	10	46	1,350
40 AT10 / 48-0	48	6	AL	152,78	150,95	-	40	30	95	16	48	1,516
40 AT10 / 60-0	60	6	AL	190,98	189,10	-	40	30	110	16	60	2,339
AT10 - Teilung 10 mm für Riemenbreite 32 mm												
47 AT10 / 18-2	18	6F	AL	57,29	55,45	60	47	37	40	10	22	0,253
47 AT10 / 19-2	19	6F	AL	60,48	58,60	66,5	47	37	44	10	22	0,286
47 AT10 / 20-2	20	6F	AL	63,66	61,80	66,5	47	37	46	12	24	0,322
47 AT10 / 22-2	22	6F	AL	70,03	68,15	75	47	37	52	12	28	0,393
47 AT10 / 24-2	24	6F	AL	76,39	74,55	83	47	37	58	12	30	0,475
47 AT10 / 25-2	25	6F	AL	79,58	77,70	83	47	37	60	12	30	0,527



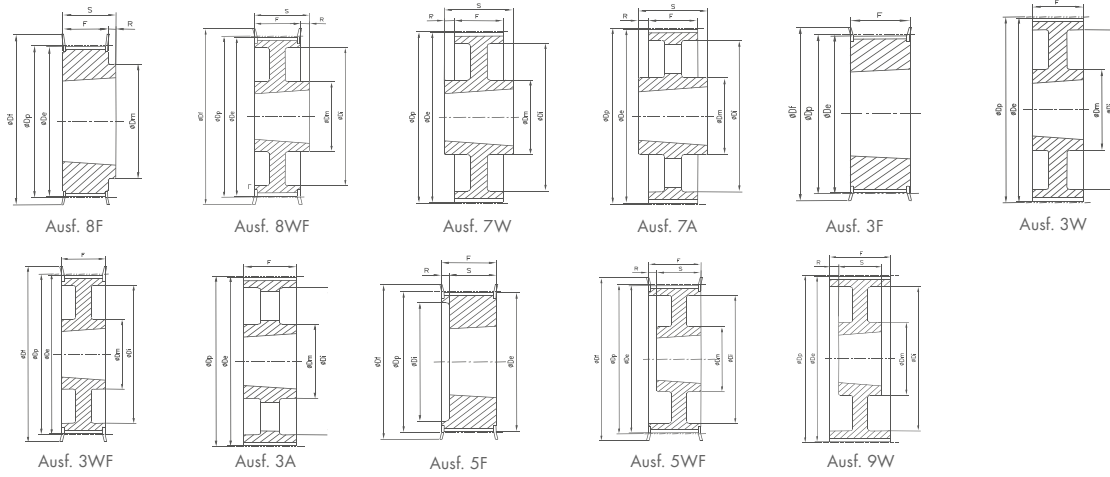

Bezeichnung	Anzahl der Zähne	Ausführung	Material	D _p (mm)	D _e (mm)	D _i (mm)	F (mm)	S (mm)	R (mm)	D _m (mm)	D _i (mm)	Taperbuchse	Gewicht ohne Buchse (≈kg)
L - Teilung 9,525 mm für Riemenbreite 050													
TB 18 L 050	18	8F	ST	54,57	53,81	60	19	22	3	40	-	1108	0,200
TB 19 L 050	19	8F	ST	57,61	56,84	64	19	22	3	40	-	1108	0,200
TB 20 L 050	20	8F	ST	60,64	59,88	66,5	19	22	3	40	-	1108	0,200
TB 21 L 050	21	8F	ST	63,67	62,91	70	19	22	3	45	-	1108	0,300
TB 22 L 050	22	8F	ST	66,70	65,94	75	19	22	3	45	-	1108	0,300
TB 23 L 050	23	8F	ST	69,73	68,97	79	19	22	3	55	-	1108	0,400
TB 24 L 050	24	8F	ST	72,77	72,00	79	19	22	3	55	-	1108	0,400
TB 25 L 050	25	8F	ST	75,80	75,04	82,5	19	22	3	58	-	1108	0,500
TB 26 L 050	26	8F	ST	78,83	78,07	86	19	22	3	58	-	1108	0,500
TB 27 L 050	27	8F	ST	81,86	81,10	86	19	22	3	58	-	1108	0,600
TB 28 L 050	28	8F	ST	84,89	84,13	91	19	22	3	58	-	1108	0,600
TB 30 L 050	30	8F	ST	90,96	90,20	97	19	22	3	70	-	1108	0,800
TB 32 L 050	32	8F	ST	97,02	96,26	102	19	22	3	70	-	1108	0,900
TB 36 L 050	36	8F	ST	109,15	108,39	115	19	22	3	70	-	1108	1,200
TB 40 L 050	40	8F	ST	121,28	120,51	128	19	25	6	70	100	1610	1,500
TB 48 L 050	48	8WF	ST	145,53	144,77	150	19	25	6	70	124	1610	2,300
TB 60 L 050	60	7W	GG	181,91	181,15	-	19	25	3	70	160	1610	2,000
TB 72 L 050	72	7A	GG	218,30	217,53	-	19	25	3	75	197	1610	3,000
TB 84 L 050	84	7A	GG	254,68	253,90	-	19	25	3	75	233	1610	4,000
TB 96 L 050	96	7A	GG	291,06	290,30	-	19	32	6,5	75	269	2012	5,500
TB 120 L 050	120	7A	GG	363,83	363,07	-	19	32	6,5	75	342	2012	6,800
L - Teilung 9,525 mm für Riemenbreite 075													
TB 18 L 075	18	3F	ST	54,57	53,81	60	25	25	-	-	-	1108	0,200
TB 19 L 075	19	3F	ST	57,61	56,84	64	25	25	-	-	-	1108	0,300
TB 20 L 075	20	3F	ST	60,64	59,88	66,5	25	25	-	-	-	1108	0,300
TB 21 L 075	21	3F	ST	63,67	62,91	70	25	25	-	-	-	1108	0,400
TB 22 L 075	22	3F	ST	66,70	65,94	75	25	25	-	-	-	1108	0,400
TB 23 L 075	23	3F	ST	69,73	68,97	79	25	25	-	-	-	1108	0,400
TB 24 L 075	24	3F	ST	72,77	72,00	79	25	25	-	-	-	1108	0,500
TB 25 L 075	25	3F	ST	75,80	75,04	83	25	25	-	-	-	1108	0,600
TB 26 L 075	26	3F	ST	78,83	78,07	87	25	25	-	-	-	1108	0,600
TB 27 L 075	27	3F	ST	81,86	81,10	87	25	25	-	-	-	1108	0,700
TB 28 L 075	28	3F	ST	84,89	84,13	91	25	25	-	-	-	1108	0,700
TB 30 L 075	30	3F	ST	90,96	90,20	97	25	25	-	-	-	1108	0,900
TB 32 L 075	32	3F	ST	97,02	96,26	102	25	25	3,5	-	-	1108	1,000
TB 36 L 075	36	3F	ST	109,15	108,39	115	25	25	3,5	-	-	1610	1,200
TB 40 L 075	40	3F	ST	121,28	120,51	128	25	25	3,5	-	-	1610	1,700



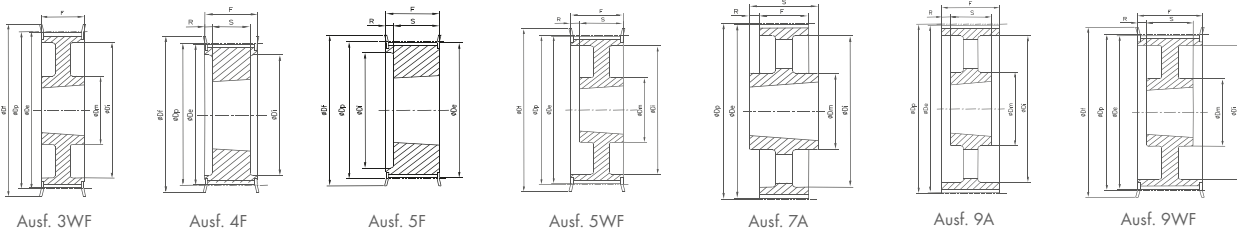

Bezeichnung	Anzahl der Zähne	Ausführung	Material	D _p (mm)	D _e (mm)	D _f (mm)	F (mm)	S (mm)	R (mm)	D _m (mm)	D _i (mm)	Taperbuchse	Gewicht ohne Buchse (≈kg)
H - Teilung 12,7 mm für Riemenbreite 100													
TB 16 H 100	16	5F	ST	64,68	63,31	70	31	22	9	-	45	1108	0,400
TB 18 H 100	18	5F	ST	72,77	71,39	79	31	25	6	-	52	1210	0,500
TB 19 H 100	19	5F	ST	76,81	75,44	82,5	31	25	6	-	56	1210	0,600
TB 20 H 100	20	5F	ST	80,55	79,48	87	31	25	6	-	60	1210	0,700
TB 21 H 100	21	5F	ST	84,89	83,52	91	32	25	7	-	64	1210	0,800
TB 22 H 100	22	5F	ST	88,94	87,56	94	32	25	7	-	67	1210	0,900
TB 23 H 100	23	5F	ST	92,98	91,61	97	32	25	7	-	70	1610	0,900
TB 24 H 100	24	5F	ST	97,02	95,65	102	32	25	7	-	74	1610	1,000
TB 25 H 100	25	5F	ST	101,06	99,69	106	32	25	7	-	77	1610	1,000
TB 26 H 100	26	5F	ST	105,11	103,73	112	32	25	7	-	82	1610	1,200
TB 27 H 100	27	5F	ST	109,15	107,78	115	32	25	7	-	85	1610	1,300
TB 28 H 100	28	5F	ST	113,19	111,82	119,0	32	25	7	-	90	1610	1,500
TB 30 H 100	30	5F	ST	121,28	119,90	127,0	32	25	7	-	98	1610	1,700
TB 32 H 100	32	5WF	ST	129,36	127,99	135,0	32	25	7	80	106	1610	2,000
TB 36 H 100	36	5WF	ST	145,53	144,16	152,0	32	25	7	92	121	1610	2,700
TB 40 H 100	40	5WF	ST	161,70	160,33	168,0	32	25	7	92	138	1610	3,600
TB 44 H 100	44	3WF	ST	177,87	176,50	184,0	32	32	-	106	152	2012	3,800
TB 48 H 100	48	3WF	ST	194,04	192,67	200,0	32	32	-	106	169	2012	3,200
TB 60 H 100	60	9A	GG	242,55	241,18	-	34	32	1	92	223	2012	4,800
TB 72 H 100	72	9A	GG	291,06	289,69	-	34	32	1	92	270	2012	5,700
TB 84 H 100*	84	9A	GG	339,57	338,20	-	34	32	1	92	318	2012	6,800
TB 96 H 100*	96	7A	GG	388,08	386,71	-	34	45	5,5	106	366	2517	8,200
TB 120 H 100*	120	7A	GG	485,10	483,73	-	34	45	5,5	106	462	2517	12,100
H - Teilung 12,7 mm für Riemenbreite 150													
TB 18 H 150	18	5F	ST	72,77	71,39	79	45	25	20	-	-	1210	0,600
TB 19 H 150	19	5F	ST	76,81	75,44	82,5	45	25	20	-	-	1210	0,700
TB 20 H 150	20	5F	ST	80,55	79,48	87	45	25	20	-	-	1210	0,800
TB 21 H 150	21	5F	ST	84,89	83,52	91	45	25	20	-	-	1210	1,000
TB 22 H 150	22	5F	ST	88,94	87,56	94	45	25	20	-	-	1210	1,200
TB 23 H 150	23	5F	ST	92,98	91,61	97	45	25	20	-	-	1610	1,300
TB 24 H 150	24	5F	ST	97,02	95,65	102	45	25	20	-	-	1610	1,200
TB 25 H 150	25	5F	ST	101,06	99,69	106	45	25	20	-	-	1610	1,200
TB 26 H 150	26	5F	ST	105,11	103,73	112	45	25	20	-	-	1610	1,400
TB 27 H 150	27	5F	ST	109,15	107,78	115	45	25	20	-	-	1610	1,600
TB 28 H 150	28	5F	ST	113,19	111,82	120	45	25	20	-	-	1610	1,800
TB 30 H 150	30	5F	ST	121,28	119,90	128	45	25	20	-	-	1610	2,000
TB 32 H 150	32	5WF	ST	129,36	127,99	135	45	25	20	80	-	1610	2,300
TB 36 H 150	36	5WF	ST	145,53	144,16	150	45	25	20	92	118	1610	3,100
TB 40 H 150	40	5WF	ST	161,70	160,33	168	45	25	20	92	134	1610	4,000
TB 44 H 150	44	5WF	ST	177,87	176,50	184	45	32	13	106	150	2012	4,400
TB 48 H 150	48	5WF	ST	194,04	192,67	200	45	32	13	106	166	2012	4,800
TB 60 H 150	60	9A	GG	242,55	241,18	-	46	32	7,5	92	215	2517	5,400
TB 72 H 150	72	9A	GG	291,06	289,69	-	46	32	7,5	92	263	2517	6,500



Bezeichnung	Anzahl der Zähne	Ausführung	Material	D _p (mm)	D _e (mm)	D _i (mm)	F (mm)	S (mm)	R (mm)	D _m (mm)	D _i (mm)	Taper-buchse	Gewicht ohne Buchse (≈kg)
TB 84 H 150*	84	9A	GG	339,57	338,20	-	46	32	7,5	92	318	2012	8,400
TB 96 H 150*	96	9A	GG	388,08	386,71	-	46	45	0,5	106	366	2517	11,000
TB 120 H 150*	120	9A	GG	485,10	483,73	-	46	45	0,5	106	462	2517	14,800
H - Teilung 12,7 mm für Riemenbreite 200													
TB 18 H 200	18	5F	ST	72,77	71,39	79	58	25	33	-	52	1210	0,800
TB 19 H 200	19	5F	ST	76,81	75,44	82,5	58	25	33	-	56	1610	0,900
TB 20 H 200	20	5F	ST	80,85	79,48	87	58	25	33	-	60	1610	1,000
TB 21 H 200	21	5F	ST	84,89	83,52	91	58	25	33	-	64	1610	1,700
TB 22 H 200	22	5F	ST	88,94	87,56	94	58	25	33	-	67	1610	1,500
TB 23 H 200	23	5F	ST	92,98	91,61	97	58	25	33	-	70	1610	1,800
TB 24 H 200	24	5F	ST	97,02	95,65	102	58	25	33	-	74	1610	1,500
TB 25 H 200	25	5F	ST	101,06	99,69	106	58	25	33	-	77	1610	1,500
TB 26 H 200	26	5F	ST	105,11	103,73	112	58	25	33	-	82	1610	1,800
TB 27 H 200	27	5F	ST	109,15	107,78	115	58	25	33	-	85	1610	1,900
TB 28 H 200	28	5F	ST	113,19	111,82	120	58	25	33	-	90	1610	1,900
TB 30 H 200	30	5F	ST	121,28	119,90	128	58	25	33	-	98	1610	2,300
TB 32 H 200	32	5F	ST	129,36	127,99	135	58	32	26	-	106	2012	3,000
TB 36 H 200	36	5WF	ST	145,53	144,16	150	58	32	26	80	121	2012	3,000
TB 40 H 200	40	5WF	ST	161,70	160,33	168	58	32	26	80	138	2012	3,600
TB 44 H 200	44	5WF	ST	177,87	176,50	184	58	32	26	80	152	2012	4,500
TB 48 H 200	48	5WF	ST	194,04	192,67	200	58	45	13	90	169	2517	4,600
TB 60 H 200	60	9A	GG	242,55	241,18	-	60	45	7,5	90	223	2517	7,000
TB 72 H 200	72	9A	GG	291,06	289,69	-	60	45	7,5	100	270	2517	8,000
TB 84 H 200*	84	9A	GG	339,57	338,20	-	60	45	7,5	100	318	2517	9,000
TB 96 H 200*	96	9A	GG	388,08	386,71	-	60	45	7,5	120	366	2517	11,500
TB 120 H 200*	120	9A	GG	485,10	483,73	-	60	45	7,5	120	462	2517	15,400
H - Teilung 12,7 mm für Riemenbreite 300													
TB 20 H 300	20	4F	ST	80,85	79,48	87	84	38	23	-	60	1615	1,500
TB 21 H 300	21	4F	ST	84,89	83,52	91	84	38	23	-	64	1615	1,200
TB 22 H 300	22	4F	ST	88,94	87,56	94	84	38	23	-	67	1615	1,600
TB 23 H 300	23	4F	ST	92,98	91,61	97	84	38	23	-	70	1615	1,800
TB 24 H 300	24	4F	ST	97,02	95,65	102	84	38	23	-	74	1615	2,100
TB 25 H 300	25	4F	ST	101,06	99,69	106	84	38	23	-	77	1615	2,000
TB 26 H 300	26	4F	ST	105,11	103,73	112	84	38	23	-	82	1615	2,700
TB 27 H 300	27	4F	ST	109,15	107,78	115	84	32	26	-	85	2012	3,000
TB 28 H 300	28	4F	ST	113,19	111,82	120	84	32	26	-	90	2012	2,400
TB 30 H 300	30	4F	ST	121,28	119,90	128	84	32	26	-	98	2012	2,900
TB 32 H 300	32	4F	ST	129,36	127,99	135	84	45	19,5	-	106	2517	3,300
TB 36 H 300	36	4F	ST	145,53	144,16	150	84	45	19,5	-	121	2517	4,500
TB 40 H 300	40	4F	ST	161,70	160,33	168	84	45	19,5	-	138	2517	6,000
TB 44 H 300	44	9WF	ST	177,87	176,50	184	86	45	20,5	-	152	2517	6,600
TB 48 H 300	48	9WF	ST	194,04	192,67	200	86	45	20,5	119	169	2517	7,600
TB 60 H 300	60	9A	GG	242,55	241,18	-	86	45	20,5	119	223	2517	8,400
TB 72 H 300	72	9A	GG	291,06	289,69	-	86	45	20,5	119	270	2517	10,400
TB 84 H 300*	84	9A	GG	339,57	338,20	-	86	45	20,5	119	318	2517	12,500
TB 96 H 300*	96	9A	GG	388,08	386,71	-	86	76	5	119	366	3030	14,200
TB 120 H 300*	120	9A	GG	485,10	483,73	-	86	76	5	119	462	3030	18,800

Taper-Buchse	1108	1210	1610	1615	2012	2517	3030
Bohrung d ₂ (mm) von... bis...	10-28	11-32	14-42	14-42	14-50	16-65	35-75

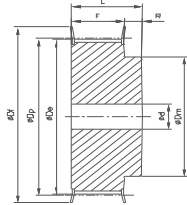

Ausf. 6F

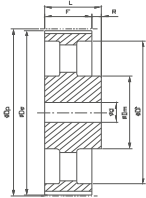

Ausf. 6A

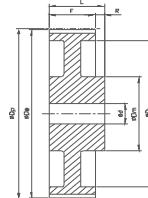

Ausf. 6W

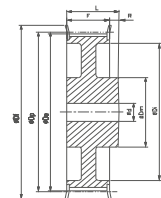

Ausf. 6WF

Bezeichnung	Anzahl der Zähne	Ausführung	Material	D _p (mm)	D _e (mm)	D _f (mm)	F (mm)	L (mm)	D _m (mm)	D _i (mm)	Vorbereitung d (mm)	Fertigbohrung d _{max} (mm)	Gewicht (≈kg)
L - Teilung 9,525 mm für Riemenbreite 050													
10 L 050	10	6F	ST	30,32	29,56	37	19	28	20	-	8	13	0,110
12 L 050	12	6F	ST	36,38	35,62	43	19	30	24	-	8	17	0,190
13 L 050	13	6F	ST	39,41	38,65	44	19	30	28	-	8	19	0,210
14 L 050	14	6F	ST	42,45	41,68	48	19	30	28	-	8	20	0,250
15 L 050	15	6F	ST	45,48	44,72	51	19	30	34	-	8	23	0,300
16 L 050	16	6F	ST	48,51	47,75	54	19	32	36	-	8	23	0,330
17 L 050	17	6F	ST	51,54	50,78	57	19	32	36	-	10	24	0,360
18 L 050	18	6F	ST	54,57	53,81	60	19	32	40	-	10	24	0,410
19 L 050	19	6F	ST	57,61	56,84	64	19	32	40	-	10	24	0,450
20 L 050	20	6F	ST	60,64	59,88	66,5	19	32	40	-	10	28	0,500
21 L 050	21	6F	ST	63,67	62,91	70	19	32	45	-	10	28	0,550
22 L 050	22	6F	ST	66,70	65,94	75	19	32	45	-	10	30	0,620
24 L 050	24	6F	ST	72,77	72,00	79	19	32	55	-	10	30	0,680
26 L 050	26	6F	ST	78,83	78,07	86	19	32	58	-	11	30	0,820
28 L 050	28	6F	ST	84,89	84,13	91	19	32	58	-	11	30	0,920
30 L 050	30	6F	ST	90,96	90,20	97	19	32	70	-	11	30	1,100
32 L 050	32	6F	ST	97,02	96,26	102	19	32	70	-	11	30	1,200
36 L 050	36	6F	ST	109,15	108,39	115	19	32	70	-	11	30	1,000
40 L 050	40	6WF	ST	121,28	120,51	128	19	32	70	100	11	30	1,100
44 L 050	44	6WF	ST	133,40	132,64	142	19	32	70	112	11	30	1,200
48 L 050	48	6WF	ST	145,53	144,77	150	19	32	70	124	11	30	1,300
60 L 050	60	6W	GG	181,91	181,15	-	19	42	75	160	14	30	1,300
72 L 050	72	6A	GG	218,30	217,53	-	19	42	75	197	14	30	1,700
84 L 050	84	6A	GG	254,68	253,92	-	19	42	75	233	14	30	1,900
L - Teilung 9,525 mm für Riemenbreite 075													
10 L 075	10	6F	ST	30,32	29,56	37	25	38	20	-	8	13	0,150
12 L 075	12	6F	ST	36,38	35,62	43	25	38	24	-	8	17	0,230
13 L 075	13	6F	ST	39,41	38,65	44	25	38	28	-	8	19	0,260
14 L 075	14	6F	ST	42,45	41,68	48	25	38	28	-	11	20	0,320
15 L 075	15	6F	ST	45,48	44,72	51	25	38	34	-	11	23	0,350
16 L 075	16	6F	ST	48,51	47,75	54	25	38	36	-	11	23	0,420
17 L 075	17	6F	ST	51,54	50,78	57	25	38	36	-	11	24	0,450
18 L 075	18	6F	ST	54,57	53,81	60	25	38	40	-	11	24	0,510
19 L 075	19	6F	ST	57,61	56,84	64	25	38	40	-	11	24	0,570
20 L 075	20	6F	ST	60,64	59,88	66,5	25	38	45	-	11	28	0,630
21 L 075	21	6F	ST	63,67	62,91	70	25	38	45	-	11	28	0,700
22 L 075	22	6F	ST	66,70	65,94	75	25	38	55	-	11	30	0,750
24 L 075	24	6F	ST	72,77	72,00	79	25	38	58	-	11	30	0,850
26 L 075	26	6F	ST	78,83	78,07	86	25	38	58	-	11	30	1,000
28 L 075	28	6F	ST	84,89	84,13	91	25	38	70	-	11	30	1,200
30 L 075	30	6F	ST	90,96	90,20	97	25	38	70	-	11	30	1,400
32 L 075	32	6F	ST	97,02	96,26	102	25	38	70	-	11	30	1,500
36 L 075	36	6F	ST	109,15	108,39	115	25,0	38	70	-	11	32	1,300
40 L 075	40	6WF	ST	121,28	120,51	128	25,0	38	70	100	11	35	1,600



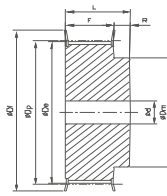

Ausf. 6F

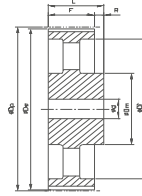

Ausf. 6A

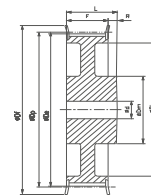

Ausf. 6WF

Bezeichnung	Anzahl der Zähne	Ausführung	Material	D _p (mm)	D _c (mm)	D _i (mm)	F (mm)	L (mm)	D _m (mm)	D ₁ (mm)	Vorbereitung d (mm)	Fertigbohrung d _{max} (mm)	Gewicht (=kg)
H - Teilung 12,7 mm für Riemenbreite 075													
14 H 075	14	6F	ST	56,60	55,22	64	26,4	40	40	-	8	24	0,500
16 H 075	16	6F	ST	64,68	63,31	70	26,4	40	45	-	8	26	0,600
18 H 075	18	6F	ST	72,77	71,39	79	26,4	40	55	-	11	32	0,800
19 H 075	19	6F	ST	76,81	75,44	82,5	26,4	40	60	-	11	35	1,000
20 H 075	20	6F	ST	80,85	79,48	87	26,4	40	62	-	11	35	1,100
21 H 075	21	6F	ST	84,89	83,52	91	26,4	40	65	-	11	38	1,200
22 H 075	22	6F	ST	88,94	87,56	94	26,4	40	68	-	11	38	1,400
24 H 075	24	6F	ST	97,02	95,65	102	26,4	40	72	-	11	42	1,600
26 H 075	26	6F	ST	105,11	103,73	112	26,4	40	80	-	11	45	1,800
28 H 075	28	6F	ST	113,19	111,82	120	26,4	40	80	-	11	45	2,000
30 H 075	30	6F	ST	121,28	119,90	128	26,4	40	80	-	11	45	2,100
32 H 075	32	6F	ST	129,36	127,99	135	26,4	40	80	-	11	45	2,200
36 H 075	36	6F	ST	145,53	144,16	150	26,4	40	80	-	11	45	2,400
40 H 075	40	6F	ST	161,70	160,33	168	26,4	40	80	-	11	45	2,800
44 H 075	44	6WF	GG	177,87	176,50	184	26,4	40	80	150	14	45	2,700
48 H 075	48	6WF	GG	194,04	192,67	200	26,4	45	90	166	14	50	3,000
H - Teilung 12,7 mm für Riemenbreite 100													
14 H 100	14	6F	ST	56,60	55,22	64	31,8	45	40	-	11	24	0,650
16 H 100	16	6F	ST	64,68	63,31	70	31,8	45	45	-	11	28	0,850
18 H 100	18	6F	ST	72,77	71,39	79	31,8	45	55	-	14	32	1,100
19 H 100	19	6F	ST	76,81	75,44	82,5	31,8	45	60	-	14	34	1,200
20 H 100	20	6F	ST	80,85	79,48	87	31,8	45	62	-	14	35	1,400
21 H 100	21	6F	ST	84,89	83,52	91	31,8	45	65	-	14	38	1,600
22 H 100	22	6F	ST	88,94	87,56	94	31,8	45	68	-	14	41	1,700
24 H 100	24	6F	ST	97,02	95,65	102	31,8	45	72	-	14	45	2,000
26 H 100	26	6F	ST	105,11	103,73	112	31,8	45	80	-	14	32	1,400
28 H 100	28	6F	ST	113,19	111,82	120	31,8	45	80	-	14	35	1,600
30 H 100	30	6F	ST	121,28	119,90	128	31,8	45	80	-	14	35	1,700
32 H 100	32	6F	ST	129,36	127,99	135	31,8	45	80	-	14	40	2,200
36 H 100	36	6WF	ST	145,53	144,16	150	31,8	45	80	118	14	45	3,000
40 H 100	40	6WF	ST	161,70	160,33	168	31,8	45	80	134	14	45	2,800
44 H 100	44	6WF	GG	177,87	176,50	184	31,8	50	80	150	14	45	3,100
48 H 100	48	6WF	GG	194,04	192,67	200	31,8	50	90	166	14	45	3,300
60 H 100	60	6A	GG	242,55	241,18	-	31,8	50	90	215	19	45	5,500
72 H 100	72	6A	GG	291,06	289,69	-	31,8	55	100	263	19	45	7,100
84 H 100*	84	6A	GG	339,57	338,20	-	31,8	55	100	312	19	45	8,200
96 H 100*	96	6A	GG	388,08	386,71	-	31,8	60	120	360	19	45	9,900
120 H 100*	120	6A	GG	485,10	483,73	-	31,8	60	120	458	19	50	13,100
H - Teilung 12,7 mm für Riemenbreite 150													
14 H 150	14	6F	ST	56,60	55,22	64	46	58	40	-	11	24	0,820
16 H 150	16	6F	ST	64,68	63,31	70	46	58	45	-	11	28	1,100
18 H 150	18	6F	ST	72,77	71,39	79	46	58	55	-	14	32	1,500
19 H 150	19	6F	ST	76,81	75,44	83	46	58	60	-	14	34	1,700
20 H 150	20	6F	ST	80,85	79,48	87	46	58	65	-	14	35	1,800



Bezeichnung	Anzahl der Zähne	Ausführung	Material	d _p (mm)	d _e (mm)	D _i (mm)	F (mm)	L (mm)	D _m (mm)	D _i (mm)	Vorbohrung d (mm)	Fertigbohrung d _{max} (mm)	Gewicht (≈kg)
21 H 150	21	6F	ST	84,89	83,52	91	46	58	65	-	14	38	2,200
22 H 150	22	6F	ST	88,94	87,56	94	46	58	68	-	14	41	2,300
24 H 150	24	6F	ST	97,02	95,65	102	46	58	72	-	14	45	2,600
26 H 150	26	6F	ST	105,11	103,73	112	46	58	80	-	14	32	1,700
28 H 150	28	6F	ST	113,19	111,82	120	46	58	80	-	14	35	1,900
30 H 150	30	6F	ST	121,28	119,90	128	46	58	80	-	14	35	2,100
32 H 150	32	6F	ST	129,36	127,99	135	46	58	80	-	14	40	2,600
36 H 150	36	6WF	ST	145,53	144,16	150	46	58	80	118	14	45	3,200
40 H 150	40	6WF	ST	161,70	160,33	168	46	58	80	134	14	45	3,800
44 H 150	44	6WF	GG	177,87	176,50	184	46	58	80	150	19	45	3,700
48 H 150	48	6WF	GG	194,04	192,67	200	46	65	90	166	19	45	4,000
60 H 150	60	6A	GG	242,55	241,18	-	46	65	90	215	19	48	5,100
72 H 150	72	6A	GG	291,06	289,69	-	46	65	100	263	24	48	7,900
84 H 150*	84	6A	GG	339,57	338,20	-	46	65	100	312	24	48	8,900
96 H 150*	96	6A	GG	388,08	386,71	-	46	65	120	360	24	48	10,100
120 H 150*	120	6A	GG	485,10	483,73	-	46	65	120	458	24	55	17,200
H - Teilung 12,7 mm für Riemenbreite 200													
14 H 200	14	6F	ST	56,60	55,22	64	58,7	70	40	-	11	24	1,100
16 H 200	16	6F	ST	64,68	63,31	70	58,7	70	45	-	11	28	1,400
18 H 200	18	6F	ST	72,77	71,39	79	58,7	70	55	-	14	32	1,800
19 H 200	19	6F	ST	76,81	75,44	82,5	58,7	70	60	-	14	34	2,100
20 H 200	20	6F	ST	80,85	79,48	87	58,7	70	62	-	14	35	2,300
21 H 200	21	6F	ST	84,89	83,52	91	58,7	70	65	-	14	38	2,600
22 H 200	22	6F	ST	88,94	87,56	94	58,7	70	68	-	14	41	2,800
24 H 200	24	6F	ST	97,02	95,65	102	58,7	70	72	-	14	45	3,400
26 H 200	26	6F	ST	105,11	103,73	112	58,7	70	80	-	14	35	2,300
28 H 200	28	6F	ST	113,19	111,82	120	58,7	70	80	-	14	35	2,500
30 H 200	30	6F	ST	121,28	119,90	128	58,7	70	80	-	14	40	2,900
32 H 200	32	6F	ST	129,36	127,99	135	58,7	70	80	-	14	40	3,200
36 H 200	36	6WF	ST	145,53	144,16	150	58,7	70	80	118	14	45	3,800
40 H 200	40	6WF	ST	161,70	160,33	168	58,7	70	80	134	14	45	4,100
44 H 200	44	6WF	GG	177,87	176,50	184	58,7	70	80	150	19	45	4,400
48 H 200	48	6WF	GG	194,04	192,67	200	58,7	75	90	166	24	48	5,100
60 H 200	60	6A	GG	242,55	241,18	-	58,7	75	90	215	24	50	7,100
72 H 200	72	6A	GG	291,06	289,69	-	58,7	75	100	263	28	50	8,000
84 H 200*	84	6A	GG	339,57	338,20	-	58,7	75	100	312	28	50	12,000
96 H 200*	96	6A	GG	388,08	386,71	-	58,7	75	120	360	28	50	13,600
120 H 200*	120	6A	GG	485,10	483,73	-	58,7	75	120	458	28	57	16,600
H - Teilung 12,7 mm für Riemenbreite 300													
16 H 300	16	6F	ST	64,68	63,31	70	85,7	100	45	-	11	28	2,000
18 H 300	18	6F	ST	72,77	71,39	79	85,7	100	54	-	19	32	2,600
19 H 300	19	6F	ST	76,81	75,44	82,5	85,7	100	60	-	19	34	2,900
20 H 300	20	6F	ST	80,85	79,48	87	85,7	100	62	-	19	35	3,200
21 H 300	21	6F	ST	84,89	83,52	91	85,7	100	65	-	19	38	3,600
22 H 300	22	6F	ST	88,94	87,56	94	85,7	100	68	-	19	41	4,000
24 H 300	24	6F	ST	97,02	95,65	102	85,7	100	72	-	19	45	4,700
26 H 300	26	6F	ST	105,11	103,73	112	85,7	100	80	-	19	35	3,300
28 H 300	28	6F	ST	113,19	111,82	120	85,7	100	80	-	19	35	3,600
30 H 300	30	6F	ST	121,28	119,90	128	85,7	100	80	-	19	40	4,200
32 H 300	32	6F	ST	129,36	127,99	135	85,7	100	80	-	19	40	4,300
36 H 300	36	6WF	ST	145,53	144,16	150	85,7	100	80	118	19	45	5,200
40 H 300	40	6WF	ST	161,70	160,33	168	85,7	100	80	134	19	45	5,600

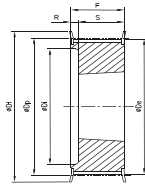

Ausf. 5F

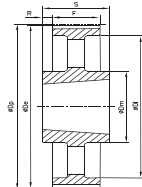

Ausf. 7A

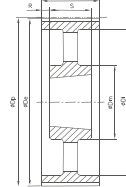

Ausf. 9A

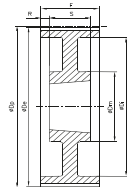

Ausf. 9W

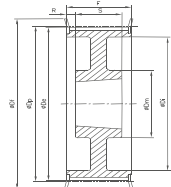

Ausf. 9WF

Bezeichnung	Anzahl der Zähne	Ausführung	Material	D _p (mm)	D _e (mm)	D _f (mm)	F (mm)	D _m (mm)	A (mm)	Vorbohrung d (mm)	Fertigbohrung d _{max} (mm)	Gewicht (≈kg)
XH - Teilung 22,225 mm für Riemenbreite 200												
18 XH 200*	18	5F	GG	127,34	124,55	140	64	-	18	20	50	5,000
20 XH 200*	20	5F	GG	141,49	138,69	155	64	-	18	20	55	6,000
22 XH 200*	22	5F	GG	155,64	152,84	170	64	-	18	20	65	7,200
24 XH 200*	24	5F	GG	169,79	166,99	184	64	-	18	25	70	8,600
26 XH 200*	26	5F	GG	183,94	181,14	198	64	-	18	25	80	10,100
28 XH 200*	28	9WF	GG	198,08	195,29	212	64	120	18	25	70	9,600
30 XH 200*	30	9WF	GG	212,23	209,44	227	64	120	18	25	70	10,400
32 XH 200*	32	9WF	GG	226,38	223,59	240	64	120	18	25	75	11,200
40 XH 200*	40	9WF	GG	282,98	280,18	297	64	160	18	25	80	16,000
48 XH 200*	48	9W	GG	339,57	336,78	-	64	160	-	30	85	18,400
60 XH 200*	60	7A	GG	424,47	421,67	-	64	190	-	30	85	24,300
72 XH 200*	72	7A	GG	509,36	506,56	-	64	190	-	40	85	28,100
84 XH 200*	84	7A	GG	594,25	591,46	-	64	190	-	40	90	31,900
96 XH 200*	96	7A	GG	679,15	676,35	-	64	190	-	40	90	37,000
XH - Teilung 22,225 mm für Riemenbreite 300												
18 XH 300*	18	5F	GG	127,34	124,55	140	90	-	35	20	50	6,800
20 XH 300*	20	5F	GG	141,49	138,69	155	90	-	35	20	55	7,400
22 XH 300*	22	5F	GG	155,64	152,84	170	90	-	35	20	65	9,000
24 XH 300*	24	5F	GG	169,79	166,99	184	90	-	35	25	70	10,600
26 XH 300*	26	5F	GG	183,94	181,14	198	90	-	35	25	80	13,000
28 XH 300*	28	5F	GG	198,08	195,29	212	90	-	35	25	70	12,000
30 XH 300*	30	5F	GG	212,23	209,44	227	90	-	35	25	70	13,000
32 XH 300*	32	5F	GG	226,38	223,59	240	90	-	35	25	75	14,700
40 XH 300*	40	9WF	GG	282,98	280,18	297	90	160	35	25	80	19,900
48 XH 300*	48	9A	GG	339,57	336,78	-	90	160	-	30	85	22,500
60 XH 300*	60	9A	GG	424,47	421,67	-	90	190	-	30	85	31,500
72 XH 300*	72	9A	GG	509,36	506,56	-	90	190	-	40	85	36,400
84 XH 300*	84	7A	GG	594,25	591,46	-	90	190	-	40	90	43,400
96 XH 300*	96	7A	GG	679,15	676,35	-	90	190	-	40	90	48,500
XH - Teilung 22,225 mm für Riemenbreite 400												
18 XH 400*	18	5F	GG	127,34	124,55	140	119	-	47	20	50	8,500
20 XH 400*	20	5F	GG	141,49	138,69	155	119	-	47	20	55	9,400
22 XH 400*	22	5F	GG	155,64	152,84	170	119	-	47	20	65	11,500
24 XH 400*	24	5F	GG	169,79	166,99	184	119	-	47	25	70	13,400
26 XH 400*	26	5F	GG	183,94	181,14	198	119	-	47	25	80	15,600
28 XH 400*	28	5F	GG	198,08	195,29	212	119	-	47	25	70	14,500
30 XH 400*	30	5F	GG	212,23	209,44	227	119	-	47	25	70	16,000
32 XH 400*	32	5F	GG	226,38	223,59	240	119	-	47	25	75	18,000
40 XH 400*	40	9WF	GG	282,98	280,18	297	119	160	47	25	80	24,000
48 XH 400*	48	9W	GG	339,57	336,78	-	119	160	-	30	85	30,800
60 XH 400*	60	9A	GG	424,47	421,67	-	119	190	-	30	85	36,200
72 XH 400*	72	9A	GG	509,36	506,56	-	119	190	-	40	85	42,700
84 XH 400*	84	9A	GG	594,25	591,46	-	119	190	-	40	90	49,700
96 XH 400*	96	9A	GG	679,15	676,35	-	119	190	-	40	90	59,900

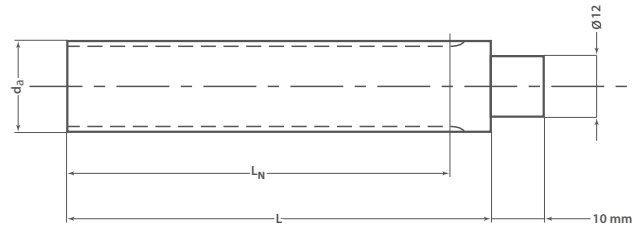

Bezeichnung	Anzahl der Zähne	Material	d _g (mm)	d _e (mm)	L _N (mm)	L (mm)
XL - Teilung 5,08 mm						
10 XL 125*	10	ST	16,17	15,66	125	140,00
11 XL 125*	11	ST	17,79	17,28	125	140,00
12 XL 125*	12	ST	19,40	18,89	125	140,00
13 XL 125*	13	ST	21,02	20,51	125	140,00
14 XL 132*	14	ST	22,64	22,13	132	140,00
15 XL 132*	15	ST	24,26	23,75	132	140,00
16 XL 140*	16	ST	25,87	25,36	140	140,00
17 XL 140*	17	ST	27,49	26,98	140	140,00
18 XL 140*	18	ST	29,11	28,60	140	140,00
19 XL 140*	19	ST	30,72	30,21	140	140,00
20 XL 140*	20	ST	32,34	31,83	140	140,00
21 XL 160*	21	ST	33,96	33,45	160	160,00
22 XL 160*	22	ST	35,57	35,06	160	160,00
23 XL 160*	23	ST	37,19	36,68	160	160,00
24 XL 160*	24	ST	38,81	38,30	160	160,00
25 XL 160*	25	ST	40,43	39,92	160	160,00
26 XL 160*	26	ST	42,04	41,53	160	160,00
27 XL 160*	27	ST	43,66	43,15	160	160,00
28 XL 160*	28	ST	45,28	44,77	160	160,00
29 XL 160*	29	ST	46,89	46,38	160	160,00
30 XL 160*	30	AL	48,51	48,00	160	160,00
32 XL 160*	32	AL	51,74	51,23	160	160,00
33 XL 160*	33	AL	53,36	52,76	160	160,00
34 XL 160*	34	AL	54,98	54,47	160	160,00
35 XL 160*	35	AL	56,60	56,09	160	160,00
36 XL 160*	36	AL	58,21	57,70	160	160,00
38 XL 160*	38	AL	61,45	60,94	160	160,00
39 XL 160*	39	AL	63,06	62,55	160	160,00
40 XL 160*	40	AL	64,68	64,17	160	160,00
41 XL 160*	41	AL	66,30	65,79	160	160,00
42 XL 160*	42	AL	67,91	67,40	160	160,00
43 XL 160*	43	AL	69,53	69,02	160	160,00
44 XL 160*	44	AL	71,15	70,64	160	160,00
48 XL 160*	48	AL	77,62	77,11	160	160,00
56 XL 160*	56	AL	90,55	90,04	160	160,00
60 XL 160*	60	AL	97,02	96,51	160	160,00
72 XL 160*	72	AL	116,43	115,92	160	160,00

ST = Stahl AL = Aluminium * Keine Lagerware.



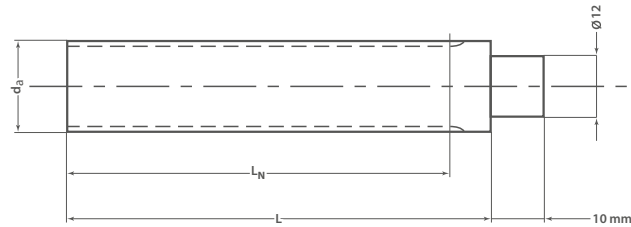

Bezeichnung	Anzahl der Zähne	Material	d _g (mm)	d _e (mm)	L _N (mm)	L (mm)
T5 - Teilung 5 mm						
125 T5 10*	10	AL	15,92	15,05	125	140,00
125 T5 11*	11	AL	17,51	16,65	125	140,00
125 T5 12*	12	AL	19,01	18,25	125	140,00
125 T5 13*	13	AL	20,70	19,85	125	140,00
132 T5 14*	14	AL	22,29	21,45	132	140,00
132 T5 15*	15	AL	23,88	23,05	132	140,00
140 T5 16*	16	AL	25,47	24,60	140	140,00
140 T5 17*	17	AL	27,06	26,20	140	140,00
140 T5 18*	18	AL	28,65	27,80	140	140,00
140 T5 19*	19	AL	30,25	29,40	140	140,00
160 T5 20*	20	AL	31,83	31,00	160	160,00
160 T5 21*	21	AL	33,43	32,70	160	160,00
160 T5 22*	22	AL	35,12	34,25	160	160,00
160 T5 23*	23	AL	36,62	35,85	160	160,00
160 T5 24*	24	AL	38,21	37,40	160	160,00
160 T5 25*	25	AL	39,80	39,00	160	160,00
160 T5 26*	26	AL	41,47	40,60	160	160,00
160 T5 27*	27	AL	42,98	42,20	160	160,00
160 T5 28*	28	AL	44,62	43,75	160	160,00
160 T5 29*	29	AL	46,17	45,35	160	160,00
160 T5 30*	30	AL	47,76	46,95	160	160,00
160 T5 32*	32	AL	50,94	50,10	160	160,00
160 T5 34*	24	AL	54,13	53,25	160	160,00
160 T5 35*	35	AL	55,72	54,85	160	160,00
160 T5 36*	36	AL	57,31	56,45	160	160,00
160 T5 37*	37	AL	58,90	58,06	160	160,00
160 T5 38*	38	AL	60,50	59,65	160	160,00
160 T5 40*	40	AL	63,66	62,85	160	160,00
160 T5 42*	42	AL	66,87	66,00	160	160,00
160 T5 44*	44	AL	70,07	69,20	160	160,00
160 T5 45*	45	AL	71,64	70,80	160	160,00
160 T5 46*	46	AL	73,23	72,40	160	160,00
160 T5 48*	48	AL	76,42	75,55	160	160,00
160 T5 50*	50	AL	79,60	78,75	160	160,00
160 T5 60*	60	AL	95,52	94,65	160	160,00
160 T5 72*	72	AL	114,62	113,75	160	160,00
160 T5 80*	80	AL	127,36	126,48	160	160,00
160 T5 90*	90	AL	143,28	142,40	160	160,00
160 T5 100*	100	AL	159,20	158,31	160	160,00

ST = Stahl AL = Aluminium * Keine Lagerware.



Bezeichnung	Teilung t (mm)	b (mm)	Material	B (mm)	a (mm)	L (mm)	e (mm)	H (mm)	d (mm)	Gewicht (≈kg)	
XL											
XL 025 CP	5,080	6,35	AL	25,5	6,00	42,50	3,50	8,00	5,50	0,020	
XL 037 CP	5,080	9,53	AL	28,5	6,00	42,50	3,50	8,00	5,50	0,025	
XL 050 CP	5,080	12,70	AL	32,0	6,00	42,50	3,50	8,00	5,50	0,027	
XL 075 CP	5,080	19,05	AL	38,0	6,00	42,50	3,50	8,00	5,50	0,032	
XL 100 CP*	5,080	25,40	AL	45,0	6,00	42,50	3,50	8,00	5,50	0,038	
L											
L 037 CP	9,525	9,53	AL	36,0	8,00	76,60	5,00	15,00	9,00	0,095	
L 050 CP	9,525	12,70	AL	39,0	8,00	76,60	5,00	15,00	9,00	0,104	
L 075 CP	9,525	19,05	AL	45,0	8,00	76,60	5,00	15,00	9,00	0,121	
L 100 CP	9,525	25,40	AL	51,5	8,00	76,60	5,00	15,00	9,00	0,140	
L 150 CP	9,525	38,10	AL	64,0	8,00	76,60	5,00	15,00	9,00	0,177	
L 200 CP	9,525	50,80	AL	77,0	8,00	76,60	5,00	15,00	9,00	0,215	
H											
H 050 CP	12,700	12,70	AL	45,0	10,00	106,90	9,00	22,00	11,00	0,050	
H 075 CP	12,700	19,05	AL	51,0	10,00	106,90	9,00	22,00	11,00	0,075	
H 100 CP	12,700	25,40	AL	57,5	10,00	106,90	9,00	22,00	11,00	0,100	
H 150 CP	12,700	38,10	AL	70,0	10,00	106,90	9,00	22,00	11,00	0,150	
H 200 CP	12,700	50,80	AL	83,0	10,00	106,90	9,00	22,00	11,00	0,200	
H 300 CP	12,700	76,20	AL	108,0	10,00	106,90	9,00	22,00	11,00	0,300	
H 400 CP*	12,700	101,60	AL	134,0	10,00	106,90	9,00	22,00	11,00	0,400	
5M											
5M 06 CP	5,000	6,00	AL	25,0	6,00	41,80	3,20	8,00	5,50	0,015	
5M 09 CP	5,000	9,00	AL	28,0	6,00	41,80	3,20	8,00	5,50	0,018	
5M 15 CP	5,000	15,00	AL	34,0	6,00	41,80	3,20	8,00	5,50	0,022	
5M 25 CP	5,000	25,00	AL	44,0	6,00	41,80	3,20	8,00	5,50	0,030	
8M											
8M 10 CP	8,000	10,00	AL	35,0	8,00	66,00	5,00	15,00	9,00	0,075	
8M 15 CP	8,000	15,00	AL	40,0	8,00	66,00	5,00	15,00	9,00	0,085	
8M 20 CP	8,000	20,00	AL	45,0	8,00	66,00	5,00	15,00	9,00	0,100	
8M 30 CP	8,000	30,00	AL	55,0	8,00	66,00	5,00	15,00	9,00	0,120	
8M 50 CP	8,000	50,00	AL	75,0	8,00	66,00	5,00	15,00	9,00	0,170	
8M 85 CP	8,000	85,00	AL	110,0	8,00	66,00	5,00	15,00	9,00	0,250	
14M											
14M 25 CP	14,000	25,00	AL	56,0	10,00	116,00	9,00	22,00	11,00	0,315	
14M 40 CP	14,000	40,00	AL	71,0	10,00	116,00	9,00	22,00	11,00	0,405	
14M 55 CP	14,000	55,00	AL	86,0	10,00	116,00	9,00	22,00	11,00	0,495	
14M 85 CP	14,000	85,00	AL	116,0	10,00	116,00	9,00	22,00	11,00	0,860	
14M 115 CP*	14,000	115,00	AL	146,0	10,00	116,00	9,00	22,00	11,00	1,195	
T5											
6 T5 CP	5,000	6,00	AL	25,0	6,00	41,80	3,20	8,00	5,50	0,020	
10 T5 CP	5,000	10,00	AL	29,0	6,00	41,80	3,20	8,00	5,50	0,025	
16 T5 CP	5,000	16,00	AL	35,0	6,00	41,80	3,20	8,00	5,50	0,030	
25 T5 CP	5,000	25,00	AL	44,0	6,00	41,80	3,20	8,00	5,50	0,036	
32 T5 CP	5,000	32,00	AL	51,0	6,00	41,80	3,20	8,00	5,50	0,042	



Bezeichnung	Teilung t (mm)	b (mm)	Material	B (mm)	a (mm)	L (mm)	e (mm)	H (mm)	d (mm)	Gewicht (=kg)
50 T5 CP*	5,000	50,00	AL	69,0	6,00	41,80	3,20	8,00	5,50	0,051
T10										
16 T10 CP	10,000	16,00	AL	41,0	8,00	80,00	5,00	15,00	9,00	0,115
25 T10 CP	10,000	25,00	AL	50,0	8,00	80,00	5,00	15,00	9,00	0,140
32 T10 CP	10,000	32,00	AL	57,0	8,00	80,00	5,00	15,00	9,00	0,160
50 T10 CP	10,000	50,00	AL	75,0	8,00	80,00	5,00	15,00	9,00	0,215
75 T10 CP*	10,000	75,00	AL	100,0	8,00	80,00	5,00	15,00	9,00	0,290
100 T10 CP*	10,000	100,00	AL	125,0	8,00	80,00	5,00	15,00	9,00	0,370
T20										
25 T20 CP	20,000	25,00	AL	56,0	10,00	160,00	10,00	20,00	11,00	0,385
32 T20 CP	20,000	32,00	AL	65,0	10,00	160,00	10,00	20,00	11,00	0,450
50 T20 CP	20,000	50,00	AL	81,0	10,00	160,00	10,00	20,00	11,00	0,570
75 T20 CP	20,000	75,00	AL	106,0	10,00	160,00	10,00	20,00	11,00	0,755
100 T20 CP*	20,000	100,00	AL	132,0	10,00	160,00	10,00	20,00	11,00	0,940
AT5										
6 AT5 CP	5,000	6,00	AL	25,0	6,00	41,80	3,20	8,00	5,50	0,016
10 AT5 CP	5,000	10,00	AL	29,0	6,00	41,80	3,20	8,00	5,50	0,019
16 AT5 CP	5,000	16,00	AL	35,0	6,00	41,80	3,20	8,00	5,50	0,024
25 AT5 CP	5,000	25,00	AL	44,0	6,00	41,80	3,20	8,00	5,50	0,031
32 AT5 CP	5,000	32,00	AL	51,0	6,00	41,80	3,20	8,00	5,50	0,036
50 AT5 CP*	5,000	50,00	AL	69,0	6,00	41,80	3,20	8,00	5,50	0,043
AT10										
16 AT10 CP	10,000	16,00	AL	41,0	8,00	80,00	5,00	15,00	9,00	0,110
25 AT10 CP	10,000	25,00	AL	50,0	8,00	80,00	5,00	15,00	9,00	0,135
32 AT10 CP	10,000	32,00	AL	57,0	8,00	80,00	5,00	15,00	9,00	0,155
50 AT10 CP	10,000	50,00	AL	75,0	8,00	80,00	5,00	15,00	9,00	0,205
75 AT10 CP	10,000	75,00	AL	100,0	8,00	80,00	5,00	15,00	9,00	0,280
100 AT10 CP*	10,000	100,00	AL	125,0	8,00	80,00	5,00	15,00	9,00	0,350
AT20										
25 AT20 CP	20,000	25,00	AL	56,0	10,00	160,00	10,00	20,00	11,00	0,385
32 AT20 CP	20,000	32,00	AL	65,0	10,00	160,00	10,00	20,00	11,00	0,450
50 AT20 CP	20,000	50,00	AL	81,0	10,00	160,00	10,00	20,00	11,00	0,570
75 AT20 CP	20,000	75,00	AL	106,0	10,00	160,00	10,00	20,00	11,00	0,755
100 AT20 CP*	20,000	100,00	AL	132,0	10,00	160,00	10,00	20,00	11,00	0,940
Bezeichnung	Teilung t (mm)	Material	L (mm)	e (mm)	H (mm)	d (mm)				
CP - Meterware										
5M*	5,000	AL	1,000	3,20	8,00	5,50				
8M*	8,000	AL	1,000	5,00	15,00	9,00				
14M*	14,000	AL	1,000	9,00	22,00	11,00				
T5*	5,000	AL	1,000	3,20	8,00	5,50				
T10*	10,000	AL	1,000	5,00	15,00	9,00				
T20*	20,000	AL	1,000	10,00	22,00	11,00				
AT5*	5,000	AL	1,000	3,20	8,00	5,50				
AT10*	10,000	AL	1,000	5,00	15,00	9,00				
AT20*	20,000	AL	1,000	10,00	22,00	11,00				



optibelt TN Anschraubnaben

Bezeichnung	Material	Taperbuchse	D _A (mm)	D _i (mm)	D +0/-0,1 (mm)	D _K (mm)	B (mm)	b (mm)	Z (mm)	B _m (mm)	d (mm)	Anzahl von d (mm)	Gewicht ohne Buchse (≈kg)
SM													
SM 12	GG	1210	180	135	90	75	25	6,50	2,5	11,5	7,50	6	1,5
SM 16	GG	1615	200	150	110	85	38	7,50	2,5	12,5	7,50	6	3,0
SM 20	GG	2012	270	190	140	110	32	8,50	2,5	13,5	9,50	6	-
SM 25	GG	2517	340	240	170	125	45	9,50	2,5	14,5	11,50	8	7,6
SM 30-1	GG	3020	430	300	220	160	51	13,50	2,5	18,5	13,50	8	16,6
SM 30-2	GG	3020	485	340	250	160	51	13,50	2,5	18,5	13,50	8	20,5

Taper-Buchse	1210	1610	1615	2012	2517	3020	3030	3525	3535	4040	4545	5050
Bohrung d ₂ (mm) von... bis...	11-32	14-42	14-42	14-50	16-65	25-75	35-75	35-90	35-90	40-100	44-110	70-125

optibelt TN Einschweissnaben Type WM

Bezeichnung	Material	Taperbuchse	D _A (mm)	D +0/-0,05 (mm)	D _K (mm)	B +0,5/-0,5 (mm)	b ₁ (mm)	b ₂ (mm)	Gewicht ohne Buchse (≈kg)
WM									
WM 1210	ST	1210	70	60	58	25	9	10	0,3
WM 1615	ST	1615	83	70	68	38	16	11	0,6
WM 2012	ST	2012	95	90	88	32	12	12	0,7
WM 2517	ST	2517	127	110	108	44	19	13	1,8
WM 3030	ST	3030	152	130	125	76	25	19	3,5
WM 3535	ST	3535	184	155	151	89	32	25	10,0
WM 4040	ST	4040	225	195	187	102	32	32	13,2
WM 4545	ST	4545	254	220	213	115	38	38	20,1
WM 5050	ST	5050	276	242	228	127	38	38	25,4

Taper-Buchse	1210	1610	1615	2012	2517	3020	3030	3525	3535	4040	4545	5050
Bohrung d ₂ (mm) von... bis...	11-32	14-42	14-42	14-50	16-65	25-75	35-75	35-90	35-90	40-100	44-110	70-125

Bohrungsdurchmesser d₂ siehe Seite 4. Weitere Abmessungen auf Anfrage. GG = Grauguss ST = Stahl Fertigungstechnische Änderungen vorbehalten.



Bezeichnung	Material	Taperbuchse	D _A (mm)	D +0/-0,05 (mm)	D _K (mm)	B +0,5/-0,5 (mm)	b ₁ (mm)	b ₂ (mm)	Gewicht ohne Buchse (≈kg)
WH									
WH 1210	ST	1210	70	65	65	25	9	10	0,3
WH 1610	ST	1610	80	75	75	25	9	10	-
WH 2012	ST	2012	95	90	90	32	12	12	-
WH 2517	ST	2517	115	110	110	44	19	15	-
WH 3020	ST	3020	145	140	140	50	19	15	2,7
WH 3525	ST	3525	190	180	180	65	25	25	-
WH 3535	ST	3535	190	180	180	89	32	25	10,0
WH 4040	ST	4040	200	190	190	101	32	30	-
WH 4545	ST	4545	210	200	200	115	40	30	-
WH 5050	ST	5050	230	220	220	127	40	35	-

Taper-Buchse	1210	1610	1615	2012	2517	3020	3030	3525	3535	4040	4545	5050
Bohrung d ₂ (mm) von... bis...	11-32	14-42	14-42	14-50	16-65	25-75	35-75	35-90	35-90	40-100	44-110	70-125

optibelt TN Zwischenhülsen

Bezeichnung	Material	Taperbuchse	D (mm)	B (mm)	Nutquerschnitt b x h (mm)	Minimaler Nabendurchmesser der Scheibe GG	Minimaler Nabendurchmesser der Scheibe GGG	Minimaler Nabendurchmesser der Scheibe ST	Gewicht ohne Buchse (≈kg)
TN Z									
1008 AM	ST	1008	45,0	22,0	5 x 2,5	71	62	56	0,1
1008 BM	ST	1008	45,0	22,0	5 x 2,5	75	67	60	0,1
1210 AM	ST	1210	60,0	25,0	6 x 3	86	79	73	0,2
1210 BM	ST	1210	60,0	25,0	6 x 3	92	86	83	0,2
1610 AM	ST	1610	70,0	25,0	10 x 4	95	89	83	0,3
1610 BM	ST	1610	70,0	25,0	10 x 4	102	95	89	0,3
1615 AM	ST	1615	70,0	38,0	10 x 4	95	89	83	0,4
1615 BM	ST	1615	70,0	38,0	10 x 4	102	95	89	0,4
2517 AM	ST	2517	105,0	45,0	16 x 4	143	133	121	1,0
2517 BM	ST	2517	105,0	45,0	16 x 4	149	140	127	1,0
3030 AM	ST	3030	130,0	76,0	20 x 5	178	165	156	2,5
3030 BM	ST	3030	130,0	76,0	20 x 5	187	175	159	2,5
3535 AM	ST	3535	160,0	89,0	22 x 5	222	203	191	5,2
3535 BM	ST	3535	160,0	89,0	22 x 5	232	213	200	5,2
4040 AM	ST	4040	185,0	102,0	24 x 5	273	248	229	8,0
4040 BM	ST	4040	185,0	102,0	24 x 5	283	157	238	8,0

Taper-Buchse	1008	1210	1610	1615	2517	3030	3535	4040
Bohrung d ₂ (mm) von... bis...	10-25	11-32	14-42	14-42	16-65	35-75	35-90	40-100

ST = Stahl GG = Grauguss GGG = Globularer Grauguss AM = Ohne Keilnut BM = Mit Keilnut
 Bohrungsdurchmesser d₂ siehe Seite 4. Weitere Abmessungen auf Anfrage. Fertigungstechnische Änderungen vorbehalten.

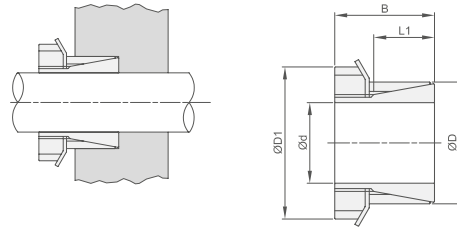

Bezeichnung	d x D mm	L ₁ (mm)	L ₂ (mm)	B (mm)	Übertragbares Drehmoment Mt (Nm)	Axialkraft F _{ax.} (kN)	Schrauben - Bezeichnung	Schrauben - Anzahl	Flächen- pression Welle P _w (N/mm ²)	Flächen- pression Nabe P _N (N/mm ²)	Schrauben - Anzugs- moment Ms (Nm)	Gewicht (kg)
CE01												
CE01 19	19x47	17	20	26	298	31	M6x18	8	286	116	14,9	0,25
CE01 20	20x47	17	20	26	313	31	M6x18	8	272	116	14,9	0,24
CE01 22	22x47	17	20	26	345	31	M6x18	8	247	116	14,9	0,23
CE01 24	24x50	17	20	26	424	35	M6x18	8	255	123	14,9	0,26
CE01 25	25x50	17	20	26	441	35	M6x18	8	245	123	14,9	0,25
CE01 28	28x55	17	20	26	549	39	M6x18	12	243	124	14,9	0,30
CE01 30	30x55	17	20	26	588	39	M6x18	12	227	124	14,9	0,29
CE01 32	32x60	17	20	26	752	47	M6x18	12	255	136	14,9	0,30
CE01 35	35x60	17	20	26	822	47	M6x18	12	233	136	14,9	0,32
CE01 38	38x65	17	20	26	1042	55	M6x18	15	250	146	14,9	0,36
CE01 40	40x65	17	20	26	1097	55	M6x18	15	238	146	14,9	0,34
CE01 42	42x75	20	24	32	1740	83	M8x22	12	291	163	35	0,48
CE01 45	45x75	20	24	32	1864	83	M8x22	12	271	163	35	0,57
CE01 48	48x80	20	24	32	1988	83	M8x22	12	254	153	35	0,59
CE01 50	50x80	20	24	32	2071	83	M8x22	12	244	153	35	0,60
CE01 55	55x85	20	24	32	2658	97	M8x22	15	259	168	35	0,63
CE01 60	60x90	20	24	32	2900	97	M8x22	15	238	158	35	0,69
CE01 65	65x95	20	24	32	3587	110	M8x22	15	250	171	35	0,73
CE01 70	70x110	24	28	38	5345	153	M10x25	15	268	171	69	1,26
CE01 75	75x115	24	28	38	5727	153	M10x25	15	250	163	69	1,33
CE01 80	80x120	24	28	38	6108	153	M10x25	15	235	156	69	1,40
CE01 85	85x125	24	28	38	7417	175	M10x25	15	252	172	69	1,49
CE01 90	90x130	24	28	38	7854	175	M10x25	15	238	165	69	1,53
CE01 95	95x135	24	28	38	9326	196	M10x25	18	254	179	69	1,62
CE01 100	100x145	26	33	45	11362	227	M12x30	15	258	178	123,3	2,01
CE01 110	110x155	26	33	45	12498	227	M12x30	15	234	166	123,3	2,15
CE01 120	120x165	26	33	45	15578	260	M12x30	16	245	178	123,3	2,35
CE01 130	130x180	34	38	50	21095	325	M12x35	20	217	156	123,3	3,51
CE01 140	140x190	34	38	50	24993	357	M12x35	22	221	163	123,3	3,85
CE01 150	150x200	34	38	50	29217	390	M12x35	24	225	169	123,3	4,07
CE01 160	160x210	34	38	50	33756	422	M12x35	26	229	174	123,3	4,30
CE01 170	170x225	38	44	58	39483	465	M14x40	22	212	160	187	5,80
CE01 180	180x235	38	44	58	45606	507	M14x40	24	218	167	187	6,00
CE01 190	190x250	46	52	66	56163	591	M14x45	28	199	152	187	8,50
CE01 200	200x260	46	52	66	63342	633	M14x45	30	203	156	187	8,60
CE01 220	220x285	50	56	72	81960	745	M16x50	26	200	154	290	11,00
CE01 240	240x305	50	56	72	103162	860	M16x50	30	211	166	290	12,00
CE01 260	260x325	50	56	72	126669	974	M16x50	34	221	177	290	13,00
CE01 280	280x355	60	66	84	157339	1124	M18x60	32	197	156	400	19,00
CE01 300	300x375	60	66	84	189653	1264	M18x60	36	207	166	400	20,00
CE01 320	320x405	72	78	98	264108	1651	M20x70	36	211	167	580	30,00



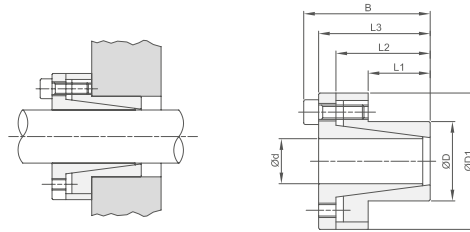

Bezeichnung	d x D mm	L ₁ (mm)	L ₂ (mm)	L ₃ (mm)	B (mm)	D ₁ (mm)	D ₂ (mm)	Übertragbares Drehmoment Mt (Nm)	Axialkraft Fax. (kN)	Flächenpressung Welle P _w (N/mm ²)	Flächenpressung Nabe P _N (N/mm ²)	Schrauben - Anzahl	Schrauben - Bezeichnung	Schrauben - Anzugsmoment Ms (Nm)	Gewicht (kg)
CE02															
CE02 08	8x15	12	21	24	28	28	32	39	10	299	159	4	M4x10	5,2	0,16
CE02 09	9x16	14	23	27	31	28	32	44	10	227	128	4	M4x12	5,2	0,16
CE02 10	10x16	14	23	27	31	28	32	49	10	205	128	4	M4x12	5,2	0,17
CE02 11	11x18	14	23	27	31	30	34	53	10	186	114	4	M4x12	5,2	0,17
CE02 12	12x18	14	23	27	31	30	34	58	10	171	114	4	M4x12	5,2	0,18
CE02 14	14x23	14	23	27	31	35	39	68	10	146	89	4	M4x12	5,2	0,20
CE02 15	15x24	16	29	36	42	40	45	120	16	196	123	4	M6x18	17	0,21
CE02 16	16x24	16	29	36	42	40	45	128	16	184	123	4	M6x18	17	0,23
CE02 18	18x26	18	31	38	44	42	47	191	21	194	134	4	M6x18	17	0,27
CE02 19	19x27	18	31	38	44	43	48	202	21	183	129	4	M6x18	17	0,29
CE02 20	20x28	18	31	38	44	44	49	213	21	174	124	4	M6x18	17	0,30
CE02 22	22x32	25	38	45	51	48	54	234	21	114	78	4	M6x18	17	0,38
CE02 24	24x34	25	38	45	51	50	56	255	21	105	74	4	M6x18	17	0,41
CE02 25	25x34	25	38	45	51	50	56	266	21	100	74	4	M6x18	17	0,45
CE02 28	28x39	25	38	45	51	55	61	373	27	112	81	5	M6x18	17	0,47
CE02 30	30x41	25	38	45	51	57	63	480	32	126	92	6	M6x18	17	0,48
CE02 32	32x43	30	43	50	56	59	65	511	32	98	73	6	M6x18	17	0,51
CE02 35	35x47	30	43	50	56	63	69	747	43	120	89	8	M6x18	17	0,63
CE02 38	38x50	30	43	50	56	66	72	811	43	110	84	8	M6x18	17	0,67
CE02 40	40x53	32	45	52	58	69	75	959	48	110	83	9	M6x18	17	0,73
CE02 42	42x55	32	45	52	58	71	77	1007	48	105	80	9	M6x18	17	0,78
CE02 45	45x59	40	56	64	72	79	85	1781	79	130	99	8	M8x22	42	1,23
CE02 48	48x62	40	56	64	72	82	88	1900	79	122	94	8	M8x22	42	1,24
CE02 50	50x65	50	66	74	82	85	92	2473	99	117	90	10	M8x22	42	1,40
CE02 55	55x71	50	66	74	82	91	98	2721	99	106	82	10	M8x22	42	1,70
CE02 60	60x77	50	66	74	82	97	104	2968	99	97	76	10	M8x22	42	1,76
CE02 65	65x84	50	66	74	82	104	111	3215	99	90	69	10	M8x22	42	2,21
CE02 70	70x90	60	80	91	101	115	122	4430	127	89	69	8	M10x25	84	3,05
CE02 75	75x95	60	80	91	101	119	126	5338	142	93	74	9	M10x25	84	3,32
CE02 80	80x100	65	85	96	106	124	131	7595	190	108	86	12	M10x25	84	3,50
CE02 85	85x106	65	85	96	106	130	137	8069	190	101	81	12	M10x25	84	3,60
CE02 90	90x112	65	85	96	106	136	143	9968	222	112	90	14	M10x25	84	3,90
CE02 95	95x120	65	85	96	106	144	153	10522	222	106	84	14	M10x25	84	4,40
CE02 100	100x125	65	89	102	114	153	162	13651	273	124	99	12	M12x30	145	4,60
CE02 110	110x140	70	94	107	119	168	177	15016	273	105	82	12	M12x30	145	8,70
CE02 120	120x155	90	114	127	139	185	195	21844	364	99	77	16	M12x30	145	10,70
CE02 130	130x165	90	114	127	139	195	205	23664	364	92	72	16	M12x30	145	11,30
CE02 140	140x175	90	114	127	139	205	215	25485	364	85	68	16	M12x30	145	11,90
CE02 150	150x185	90	114	127	139	215	225	27305	364	80	64	16	M12x30	145	12,50

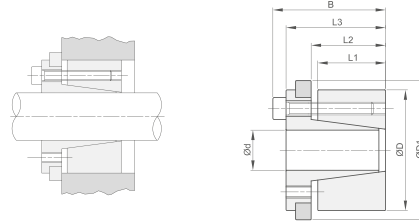

Bezeichnung	d x D mm	L ₁ (mm)	L ₂ (mm)	L ₃ (mm)	B (mm)	D ₁ (mm)	Übertragbares Drehmoment Mt (Nm)	Axialkraft F ax. (kN)	Flächenpressung Welle P _w (N/mm ²)	Flächenpressung Nabe P _N (N/mm ²)	Schrauben - Anzahl	Schrauben - Bezeichnung	Schrauben - Anzugsmoment Ms (Nm)	Gewicht (kg)	
CE06															
CE06 19	19x47	26	31	39	45	53	202	21	127	51	4	M6x20	17	0,45	
CE06 20	20x47	26	31	39	45	53	213	21	121	51	4	M6x20	17	0,46	
CE06 22	22x47	26	31	39	45	53	234	21	110	51	4	M6x20	17	0,50	
CE06 24	24x50	26	31	39	45	56	384	32	151	73	6	M6x20	17	0,50	
CE06 25	25x50	26	31	39	45	56	400	32	145	73	6	M6x20	17	0,50	
CE06 28	28x55	26	31	39	45	61	448	32	129	66	6	M6x20	17	0,60	
CE06 30	30x55	26	31	39	45	61	480	32	121	66	6	M6x20	17	0,60	
CE06 32	32x60	26	31	39	45	66	683	43	151	81	8	M6x20	17	0,70	
CE06 35	35x60	26	31	39	45	66	747	43	138	81	8	M6x20	17	0,60	
CE06 38	38x65	26	31	39	45	71	811	43	127	74	8	M6x20	17	0,80	
CE06 40	40x65	26	31	39	45	71	853	43	121	74	8	M6x20	17	0,60	
CE06 42	42x75	30	36	47	55	81	1216	58	135	76	6	M8x30	41	1,20	
CE06 45	45x75	30	36	47	55	81	1302	58	126	76	6	M8x30	41	1,10	
CE06 48	48x80	30	36	47	55	86	1389	58	119	71	6	M8x30	41	1,30	
CE06 50	50x80	30	36	47	55	86	1447	58	114	71	6	M8x30	41	1,10	
CE06 55	55x85	30	36	47	55	91	2124	77	138	89	8	M8x30	41	1,20	
CE06 60	60x90	30	36	47	55	96	2317	77	127	84	8	M8x30	41	1,30	
CE06 65	65x95	30	36	47	55	101	2510	77	117	80	8	M8x30	41	1,40	
CE06 70	70x110	40	46	57	67	116	4381	125	132	84	8	M10x35	83	2,50	
CE06 75	75x115	40	46	62	72	121	4694	125	123	80	8	M10x35	83	2,60	
CE06 80	80x120	40	46	62	72	126	5007	125	115	77	8	M10x35	83	2,80	
CE06 85	85x125	40	46	62	72	131	6651	156	136	92	10	M10x35	83	2,80	
CE06 90	90x130	40	46	62	72	136	7042	156	128	89	10	M10x35	83	3,00	
CE06 95	95x135	40	46	62	72	141	7433	156	121	85	10	M10x35	83	3,00	
CE06 100	100x145	46	52	77	89	151	9104	182	117	81	8	M12x45	145	5,50	
CE06 110	110x155	46	52	77	89	161	10015	182	106	75	8	M12x45	145	4,80	
CE06 120	120x165	46	52	77	89	171	13653	228	122	88	10	M12x45	145	5,50	
CE06 130	130x180	46	52	77	89	186	17747	273	135	97	12	M12x45	145	6,00	
CE06 140	140x190	51	59	84	98	196	17328	248	102	75	8	M14x45	230	7,50	
CE06 150	150x200	51	59	84	98	206	23207	309	119	89	10	M14x45	230	7,70	
CE06 160	160x210	51	59	84	98	216	24754	309	112	85	10	M14x45	230	8,00	
CE06 170	170x225	51	59	84	98	231	31561	371	126	95	12	M14x45	230	9,80	
CE06 180	180x235	51	59	84	98	241	33417	371	119	91	12	M14x45	230	9,80	

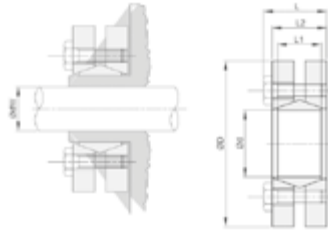

Bezeichnung	d _w (mm)	D (mm)	L ₁ (mm)	L ₂ (mm)	L (mm)	Flächen- pressung Welle P _w (N/mm ²)	Drehmo- ment M (Nm)	Axialkraft F (kN)	Schrauben - Anzahl	Schrauben - Bezeich- nung	Schrauben - Anzugs- moment M _s (Nm)	Gewicht (kg)
CE14												
CE14 24	19	50	14	19,5	23	272	162	15,0	6	M5x18	4,9	0,20
	20						200	18,5				
	21						238	21,0				
CE14 30	24	60	16	21,5	25	221	285	15,7	7	M5x18	4,9	0,30
	25						323	23,7				
	26						361	26,7				
CE14 36	28	72	18	23,5	27,5	292	418	27,0	5	M6x20	11,8	0,40
	30						542	38,0				
	31						599	43,0				
CE14 44	32	80	20	25,5	29,5	301	589	44,0	7	M6x20	11,8	0,60
	35						741	49,0				
	36						817	54,0				
CE14 50	38	90	22	27,5	31,5	275	893	48,8	8	M6x25	11,8	0,80
	40						1102	58,8				
	42						1311	69,0				
CE14 55	42	100	23	30,5	34,5	239	1102	48,0	8	M6x25	11,8	1,10
	45						1444	61,7				
	48						1786	77,0				
CE14 62	48	110	23	30,5	34,5	265	1758	69,0	10	M6x25	11,8	1,30
	50						2090	80,9				
	52						2280	90,0				
CE14 68	50	115	23	30,5	34,5	242	1900	71,2	10	M6x25	11,8	1,40
	55						2375	80,9				
	60						2993	95,7				
CE14 75	55	138	25	32,5	37,8	259	2375	94,4	7	M8x30	29,4	1,70
	60						3040	111,0				
	65						3753	126,0				
CE14 80	60	145	25	32,5	37,8	243	3040	99,3	7	M8x30	29,4	1,90
	65						7505	115,0				
	70						4370	130,0				
CE14 90	65	155	30	39	44,3	257	4513	141,0	10	M8x35	29,4	3,30
	70						5700	160,0				
	75						6888	178,0				
CE14 100	70	170	34	44	49,3	245	6555	163,0	12	M8x35	29,4	4,70
	75						7125	182,0				
	80						8550	202,0				
CE14 110	75	185	39	50	56,4	232	6840	185,0	9	M10x40	57,8	5,90
	80						8550	207,0				
	85						10260	221,0				



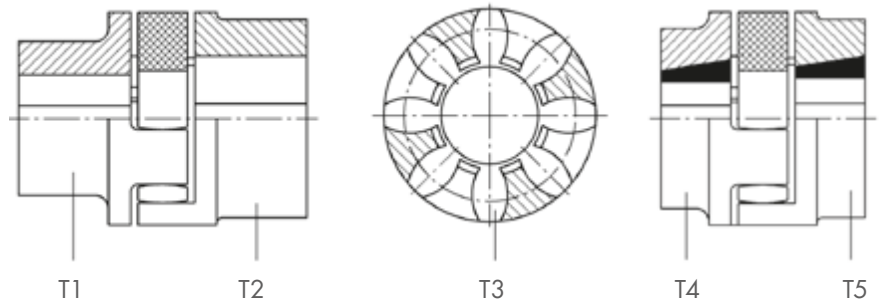

Werkstoff	Größe	Nabe un-/ vorgebohrt				Nabe fertiggebohrt*		Nabe mit TB-Bohrung						Kupplungsstern aus PUR		
		T1		T2		T1	T2	T3			T4			T5		
		Bezeichnung	€	Bezeichnung	€	€	€	Bezeichnung	€	Buchse	Bezeichnung	€	Buchse	Bezeichnung		€
													92 Shore A	98 Shore A		
Grauguss	19	HWN1-19		HWN2-19										STERNH19	STERNH1998	
	24	HWN1-24		HWN2-24				HWT3-24	1008		HWT4-24	1008		STERNH24	STERNH2498	
	28	HWN1-28		HWN2-28				HWT3-28	1108		HWT4-28	1108		STERNH28	STERNH2898	
	38	HWN1-38		HWN2-38				HWT3-38	1108		HWT4-38	1108		STERNH38	STERNH3898	
	42	HWN1-42		HWN2-42				HWT3-42	1610		HWT4-42	1610		STERNH42	STERNH4298	
	48	HWN1-48		HWN2-48				HWT3-48	1615		HWT4-48	1615		STERNH48	STERNH4898	
	55	HWN1-55		HWN2-55				HWT3-55	2012		HWT4-55	2012		STERNH55	STERNH5598	
	65	HWN1-65		HWN2-65				HWT3-65	2012		HWT4-65	2517		STERNH65	STERNH6598	
	75	HWN1-75		HWN2-75				HWT3-75	2517		HWT4-75	3020		STERNH75	STERNH7598	
	90	HWN1-90		HWN2-90				HWT3-90	3020		HWT4-90	3535		STERNH90	STERNH9098	

* Preise der fertiggebohrten Naben sind ausschließlich für das Lagerprogramm lt. nachfolgenden Auflistungen gültig.
Presie für andere Fertigbohrungen siehe Tabelle S.5



Nabe fertiggebohrt¹⁾ T1 / HWN1-(Größe)

Größe Bohrung Ø	HWN1-19	HWN1-24	HWN1-28	HWN1-38	HWN1-42	HWN1-48	HWN1-55	HWN1-65	HWN1-75	HWN1-90
10	*									
11	*									
12	*	*								
14	*	*	*							
15	*	*	*							
16	*	*	*	*						
18	*	*	*	*						
19	*	*	*	*						
20		*	*	*	*					
22		*	*	*	*					
24		*	*	*	*	*				
25			*	*	*	*	*			
28			*	*	*	*	*			
30				*	*	*	*			
32				*	*	*	*	*		
35				*	*	*	*	*	*	
38				*	*	*	*	*	*	
40					*	*	*	*	*	
42					*	*	*	*	*	
45						*	*	*	*	*
48						*	*	*	*	*
50							*	*	*	*
55							*	*	*	*
60								*	*	*
65								*	*	*
70									*	*
75									*	*
80										*
85										*
90										*

 Nabe fertiggebohrt¹⁾ T2 / HWN2-(Größe)

Größe Bohrung Ø	HWN2-19	HWN2-24	HWN2-28	HWN2-38	HWN2-42	HWN2-48	HWN2-55	HWN2-65	HWN2-75	HWN2-90
20	*									
22	*									
24	*									
25	*	*								
28		*								
30		*	*							
32		*	*							
35			*							
38			*							
40			*	*						
42				*						
45				*	*					
48				*	*					
50					*	*				
55					*	*				
60						*	*			
65							*			
70							*	*		
75								*		
80									*	

¹⁾ Naben ØH7 Nut DIN 6885/1JS9, mit Feststellgewinde

* verfügbar in dieser Größe



Bauart HPN



Bauart HPK

Werkstoff	Größe	Nabe Vorgebohrt H7						Nabe Fertiggebohrt *		Kupplungsstern aus PUR	
		HPN			HPK			HPN	HPK	98 Shore A	
		Bezeichnung	Vorbohrung Ø	€	Bezeichnung	Vorbohrung Ø	€	€	€	Bezeichnung	€
Alu	19	HPN-19	5		HPK-19	5				STERNHP1998	
	24	HPN-24	9		HPK-24	8				STERNHP2498	
	28	HPN-28	11		HPK-28	12				STERNHP2898	
	38	HPN-38	16		HPK-38	13				STERNHP3898	
	48	HPN-48	20		HPK-48	20				STERNHP4898	
	65	HPN-65	29		HPK-65	29				STERNHP6598	

* Preise der fertiggebohrten Naben sind ausschließlich für das Lagerprogramm lt. nachfolgenden Auflistungen gültig.
Preise für andere Fertigbohrungen siehe Tabelle S.5

Nabe fertiggebohrt¹⁾ HPN-(Größe)

Größe Bohrung Ø	HPN-19	HPN-24	HPN-28	HPN-38	HPN-48	HPN-65
10						
11						
12	*					
14	*					
15						
16						
18						
19	*	*				
20		*	*			
22						
24	*	*				
25		*	*	*		
28						
30			*			
32			*	*		
35				*		
38						
40				*	*	*
42						
45						
48						
50						
55					*	
60						
65						

1) Naben ØH7 Nut DIN 6885/1-JS9, mit Feststellgewinde

 Nabe fertiggebohrt²⁾ HPK-(Größe)

Größe Bohrung Ø	HPN-19	HPN-24	HPN-28	HPN-38	HPN-48	HPN-65
10	*					
11						
12	*					
14	*	*				
15						
16	*	*				
18						
19	*					
20	*	*				
22		*				
24	*	*	*			
25		*		*		
28						
30		*	*			
32			*			
35			*	*		
38				*		
40				*	*	
42					*	
45						
48						
50						
55					*	*
60						
65						

2) Naben Ø H7, ohne Nut * verfügbar in dieser Größe



FW

FNW

Bauart F

Größe	Nabe Klauteil		Nabe Taschenteil		Stück je Kupplung	Ersatzpakete			
	un-/ vorgebohrt		un-/ vorgebohrt mit Perbunanpakete			Abmessung	Perbunan		
	Bezeichnung	€	Bezeichnung	€			mm	Bezeichnung	€
FW 2-teilig	1	F1K		F1PT	3	20 x 20 x 10	P20X20X10		
	2	F2K		F2PT	4	20 x 20 x 10	P20X20X10		
	3	F3K		F3PT	5	20 x 20 x 10	P20X20X10		
	4	F4K		F4PT	5	20 x 20 x 10	P20X20X10		
	5	F5K		F5PT	6	25 x 20 x 12	P25X20X12		
	6	F6K		F6PT	6	36 x 25 x 15	P36X25X15		
	7	F7K		F7PT	7	36 x 25 x 15	P36X25X15		
	8	F8K		F8PT	7	45 x 30 x 20	P45X30X20		
	9	F9A		F9PT	8	45 x 30 x 20	P45X30X20		
	9a	F9AK		F9APT	8	60 x 40 x 25	P60X40X25		
	10	F10K		F10PT	8	60 x 40 x 25	P60X40X25		
	10a	*	*	*	*	10	60 x 40 x 25	P60X40X25	
	11	*	*	*	*	10	60 x 40 x 25	P60X40X25	
12	*	*	*	*	8	80 x 60 x 30	P80X60X30		
13	*	*	*	*	8	80 x 60 x 30	P80X60X30		
FNW 3-teilig	6	FN6		F6PT	6	36 x 25 x 15	P36X25X15		
	7	FN7		F7PT	7	36 x 25 x 15	P36X25X15		
	8	FN8		F8PT	7	45 x 30 x 20	P45X30X20		
	9	FN9		F9PT	8	45 x 30 x 20	P45X30X20		
	9a	*	*	F9APT*	8	60 x 40 x 25	P60X40X25		
	10	*	*	F10PT*	8	60 x 40 x 25	P60X40X25		
	10a	*	*	*	*	10	60 x 40 x 25	P60X40X25	
	11	*	*	*	*	10	60 x 40 x 25	P60X40X25	
	12	*	*	*	*	8	80 x 60 x 30	P80X60X30	
	13	*	*	*	*	8	80 x 60 x 30	P80X60X30	
	14	*	*	*	*	8	80 x 60 x 30	P80X60X30	
	15	*	*	*	*	8	80 x 60 x 30	P80X60X30	
	16	*	*	*	*	8	110 x 80 x 40	P110X80X40	

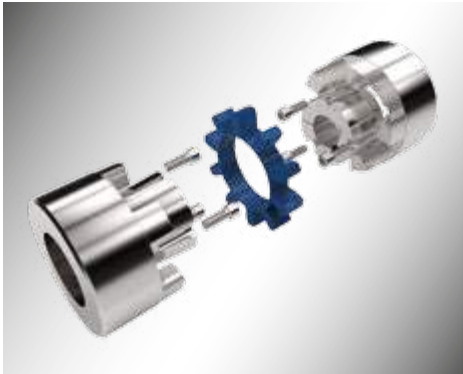

TX 03



XW1

Bauart TX für Taper-Spannbuchsen

Größe	Buchsen Nr.	Nabe ohne Buchse		Kupplungsstern aus PUR		
		Bezeichnung	€	Bezeichnung		€
				92 Shore A	98 Shore A	
TX 03	28	1108	TX01 28H	STERNTX 28	ADITX 28	
	42	1610	TX01 42H	STERNTX 42	ADITX 42	
	60	2517	TX01 60H	STERNTX 60	ADITX 60	
	75	3020	TX01 75H	STERNTX 75	ADITX 75	
	90	3535	TX01 90H	STERNTX 90	ADITX 90	
	110	4545	TX01 110H	STERNTX 110	ADITX 110	

Bauart XW

Größe	Nabe un- / vorgebohrt		Kupplungsersatzstern aus PUR			
	Bezeichnung	€	92 Shore A	98 Shore A	€	
XW 1	24	X1 24H		STERN 24	ADI 24	
	28	X1 28H		STERN 28	ADI 28	
	32	X1 32H		STERN 32	ADI 32	
	38	X1 38H		STERN 38	ADI 38	
	42	X1 42H		STERN 42	ADI 42	
	48	X1 48H		STERN 48	ADI 48	
	55	X1 55H		STERN 55	ADI 55	
	60	X1 60H		STERN 60	ADI 60	
	65	X1 65H		STERN 65	ADI 65	
	75	X1 75H		STERN 75	ADI 75	
	85	X1 85H		STERN 85	ADI 85	
	100	X1 100H		STERN 100	ADI 100	
	110	X1 110H		STERN 110	ADI 110	
	125	X1 125H		STERN 125	ADI 125	
	140	X1 140H		STERN 140	ADI 140	
	160	X1 160H		STERN 160	ADI 160	

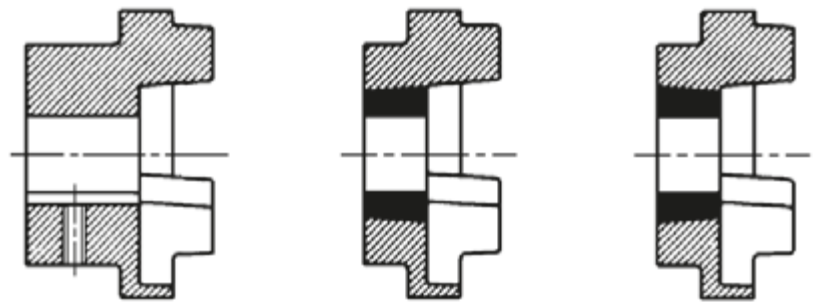

B

F

H

Größe	B-Flansch vorgebohrt		F-Flansch			H-Flansch			Kupplungsstern aus NBR 80 Shore 1	
	Bezeichnung	€	Bezeichnung	€	Buchse	Bezeichnung	€	Buchse	Bezeichnung	€
70	HRC 70B		HRC 70F		1008	HRC 70H		1008	STERNHRC 70	
90	HRC 90B		HRC 90F		1108	HRC 90H		1108	STERNHRC 90	
110	HRC 110B		HRC 110F		1610	HRC 110H		1610	STERNHRC 110	
130	HRC 130B		HRC 130F		1610	HRC 130H		1610	STERNHRC 130	
150	HRC 150B		HRC 150F		2012	HRC 150H		2012	STERNHRC 150	
180	HRC 180B		HRC 180F		2517	HRC 180H		2517	STERNHRC 180	
230	HRC 230B		HRC 230F		3020	HRC 230H		3020	STERNHRC 230	
280	HRC 280B		HRC 280F		3525	HRC 280H		3525	STERNHRC 280	



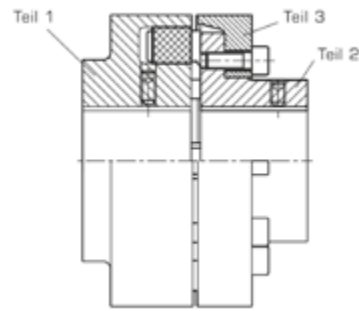

Typ A

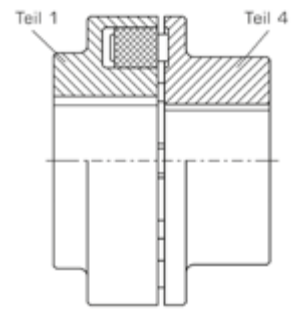

Typ B

Größe	Nabe un- / vorgebohrt						Elastomerpakete aus NBR		Stück per Satz	
	Teil 1 inkl. Pakete 80 Shore A		Teil 2+3		Teil 4		Satz 80 Shore A			
	Bezeichnung	€	Bezeichnung	€	Bezeichnung	€	Bezeichnung	€		
58	DP 58PT					DP 58KB		PDP 58		4
68	DP 68PT					DP 68KB		PDP 68		5
80	DP 80PT					DP 80KB		PDP 80		6
95	DP 95PT					DP 95KB		PDP 95		6
110	DP 110PT		DP 110KA			DP 110KB		PDP 110		6
125	DP 125PT		DP 125KA			DP 125KB		PDP 125		6
140	DP 140PT		DP 140KA			DP 140KB		PDP 140		6
160	DP 160PT		DP 160KA			DP 160KB		PDP 160		7
180	DP 180PT		DP 180KA			DP 180KB		PDP 180		8
200	DP 200PT		DP 200KA			DP 200KB		PDP 200		8
225	DP 225PT		DP 225KA			DP 225KB		PDP 225		8
250	DP 250PT		DP 250KA			DP 250KB		PDP 250		8
280								PDP 280		8
315								PDP 315		9
350								PDP 350		9
400								PDP 400		10
440								PDP 440		10
480								PDP 480		10
520								PDP 520		10
560								PDP 560		10



Größe 105 bis 360



Größe 400 bis 2000

Bauart WN (Bauart WS auf Anfrage)

Größe	Nabe Lochteil		Nabe Bolzenteil inkl. Puffer + Bolzen		Puffer + Bolzen		Ersatzpuffer			
	un-/ vorgebohrt		un-/ vorgebohrt				Stück je Kupplung	Abmessung	Perbunan	
	Bezeichnung	€	Bezeichnung	€	Bezeichnung	€			D x d x lg	Bezeichnung
105	WN 105L		WN 105B		PBO20		8	20 x 8 x 19	PO20	
125	WN 125L		WN 125B		PBO24		8	24 x 10 x 22	PO24	
144	WN 144L		WN 144B		PBO24		10	24 x 10 x 22	PO24	
162	WN 162L		WN 162B		PBO30		9	30 x 12 x 27	PO30	
178	WN 178L		WN 178B		PBO30		10	30 x 12 x 27	PO30	
198	WN 198L		WN 198B		PBO30		12	30 x 12 x 27	PO30	
228	WN 228L		WN 228B		PBO40		11	40 x 16 x 33	PO40	
252	WN 252L		WN 252B		PBO40		12	40 x 16 x 33	PO40	
285	WN 285L		WN 285B		PBO48		11	48 x 20 x 41	PO48	
320	WN 320L		WN 320B		PBO48		12	48 x 20 x 41	PO48	
360	WN 360L		WN 360B		PBO64		10	64 x 25 x 51	PO64	
400					PBO64		14	64 x 25 x 51	PO64	
450					PBO78		12	78 x 32 x 63	PO78	
500					PBO78		14	78 x 32 x 63	PO78	
560					PBO101		12	101 x 42 x 80	PO101	
630					PBO101		14	101 x 42 x 80	PO101	
710					PBO120		14	120 x 50 x 96	PO120	
800					PBO120		16	120 x 50 x 96	PO120	
900										
1000										
1120										
1250										
1400										
1600										
1800										
2000										

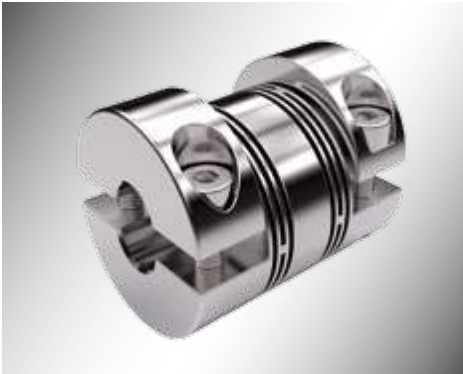

MWK

Typ MWK (Typ MWH auf Anfrage)

Typ	Größe	Aluminium vorgebohrt		Edelstahl vorgebohrt		Stahl vorgebohrt	
		Bezeichnung	€	Bezeichnung	€	Bezeichnung	€
MWK vorgebohrt	18	MWKA 18		MWKE 18			
	20	MWKA 20		MWKE 20			
	22	MWKA 22		MWKE 22			
	25	MWKA 25		MWKE 25			
	30	MWKA 30		MWKE 30			
	40	MWKA 40		MWKE 40			
	50	MWKA 50		MWKE 50			
	60	MWKA 60					MWKS 60
	70	MWKA 70					MWKS 70
	80	MWKA 80					MWKS 80

Inhaber sämtlicher Urheber- und Leistungsschutzrechte sowie sonstiger Nutzungs- und Verwertungsrechte:
Arntz Optibelt Unternehmensgruppe, Höxter/Deutschland. Jegliche Nutzung, Verwertung, Vervielfältigung oder jegliche Weitergabe an Dritte bedarf der vorherigen schriftlichen Genehmigung durch die Arntz Optibelt Unternehmensgruppe, Höxter/Deutschland.

Print: 0318 – PRME-18PLD1-XM

Optibelt GmbH

Corveyer Allee 15
37671 Hörter
GERMANY

T +49 5271 621
F +49 5271 976200
E info@optibelt.com



www.optibelt.com